

KWIKSET

KNOB LOCKS

- ANSI/BHMA Grade 2 Certified.
- Compatible With Kwikset's 5-Pin Keying Systems.
- 6-Pin, Front Removable Cylinder (cylinder removal tool required)
- Lifetime Mechanical Warranty.
- Lifetime Finish Warranty.

Kwikset
Signature Series

12 locks per case
Dummy-20 locks per case



ABBEY (A)
US-3, 5, 26D



CIRCA (CA)
US-3, 5, 10B, 11P, 15, 15A, 26, 26D
(730CA also 3x26, 5x26)



COPA (C)
US-3, 5, 15A, 26, 26D
(SmartKey only)



LAUREL (L)
US-3, 5, 10B, 11P, 15, 15A, 26
(740L also LO3)



HANCOCK (H)
US-3, 5, 10B, 11P, 15, 15A, 26D
(740H also LO3)



CAMERON (CN)
US-3, 5, 11P, 15,
15A, 26

To Order, Specify:

Function: **740** Entry
Design: **CA** Circa
Finish: **US-3** Polished Brass
Latch: **6WAL** 6-way adjustable

See page 160 for details on 6WAL latch.

SPECIFICATIONS

DOOR THICKNESS: 1-3/8" to 1-3/4".
***BACKSET:** 6WAL-Adjustable latch for 2-3/8", 2-3/4" with Square Face/Round Face/Drive-in.
***STRIKE:** RCS, SCS
*Selection may be limited.
BORE: 2-1/8" x 1"
ROSE: 2-5/8"
CYLINDER: 6-pin. 5 pin SmartKey also available on some designs.
KEY BLANK: KW-81208 (KW-88260)
FINISHES:
US-LO3 (605E) Polished Brass-Lifetime
US-3 (605) Polished Brass
US-5 (609) Antique Brass
***US-10B** (613) Oil Rubbed Bronze
US-11P Venetian Bronze
US-15 (619) Satin Nickel
US-15A (620) Antique Nickel
US-26 (625) Polished Chrome
US-26D (626) Satin Chrome
***NOTE:** The factory is discontinuing the 10B finish.

Kwikset SMART KEY

BUMPGUARD™
Patented side locking bar technology replaces a traditional pin & tumbler design to protect against lock bumping.

DRILL RESISTANCE
Cylinder uses two steel balls inserted into the front of the key face to resist attack from drilling.

NEW TECHNOLOGY
Locking bar, racks and pins are made out of stainless steel for increased strength and durability.

KEY IT YOURSELF
Lock is rekeyable by using the included learn tool in less than 30 seconds without removing the lock from the door.

See page 172 for "How to re-key a SmartKey cylinder"

Function	No.	Operation
PASSAGE/HALL/CLOSET	720	Both knobs always free.
PRIVACY/BED/BATH	730	Both knobs locked or unlocked by turnbutton inside. Outside knob unlocked by emergency key. (KW-81087)
PRIVACY/BATHROOM	730	Same function as 730 above. Inside knob polished chrome.
ENTRY	740	Both knobs locked or unlocked by key outside and turnbutton inside.
ENTRY (Being Discontinued)	741	Outside knob locked or unlocked by key outside or turnbutton inside. Inside always free.
CLASSROOM	744	Outside locked or unlocked by key outside. Inside always free. (ABBEY only)
STOREROOM/VESTIBULE	750	Outside unlocked only while key is turned. Inside always free.
1/2 DUMMY	788	For doors where only a pull is required. Surface mounted.

©ZIPF LOCK COMPANY

SUPER SPECIAL PRICING AVAILABLE ON ITEMS MARKED WITH ■ - SUPPLIES LIMITED - PLEASE INQUIRE.

153_{v2}
(PL-8)

KWIKSET

LEVER LOCKS

- ANSI/BHMA Grade 2 Certified.
- Compatible With Kwikset's 5-Pin Keying Systems.
- 6-Pin Cylinder.
- Lifetime Mechanical Warranty.
- Lifetime Finish Warranty.

Kwikset
Signature Series

12 locks per case
Dummy - 20 locks per case

Functions 720, 788 satisfy section 4.13.9 ADA requirement.

To Order, Specify:

Function : **740** *Entry*
Design: **CHL** *Commonwealth*
Finish: **US-3** *Polished Brass*
Latch: **6WAL** *6-way Adjustable Latch*

See page 160 for details on 6WAL latch.

>>>>Handing required on 788 Dummy functions<<<<<
(SEE PAGE 156 FOR HOW TO DETERMINE HANDING)

SPECIFICATIONS

DOOR THICKNESS: 1-3/8" to 1-3/4"
***BACKSET:** 6WAL-Adjustable latch for 2-3/8", 2-3/4" with Square Face/Round Face/Drive-in.
***STRIKE:** RCS, SCS
*Selection may be limited.
BORE: 2-1/8" x 1"
ROSE: 2-5/8"
CYLINDER: 6-pin. 5 pin SmartKey also available on some designs.
KEY BLANK: KW-81208 (KW-88260)
FINISHES:
US-LO3 (605E) Polished Brass-Lifetime
US-3 (605) Polished Brass
US-5 (609) Antique Brass
***US-10B** (613) Oil Rubbed Bronze
US-11P Venetian Bronze
US-15 (619) Satin Nickel
US-15A (620) Antique Nickel
US-26 (625) Polished Chrome
US-26D (626) Satin Chrome
US-514 Iron Black

*NOTE: The factory is discontinuing the 10B finish.

UPGRADE YOUR SIGNATURE SERIES LEVERS

(Sold separately)



KW-83319 ART

US-11P, 15, 514



KW-83318 OVT

US-11P, 15, 514

Fits all SmartKey, passage, privacy or dummy Signature Series reversible levers.



ASHFIELD (ADL)

US-3, 11P, 15, 514



AVALON (AVL)

US-3, 11P, 15, 514



BROOKLANE (BRL)

US-3, 5, 10B, 11P, 15, 15A, 26, 26D
(740BRL also LO3)

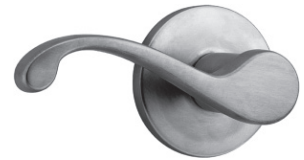

COMMONWEALTH (CHL)

US-3, 5, 10B, 11P, 15, 15A, 26, 26D
(740CHL also LO3)



LIDO (LL)

US-3, 5, 11P, 15, 15A, 26, 26D



TUSTIN (TNL)

US-3, 5, 11P, 15, 15A, 26, 26D



PEMBROKE (PML)

US-LO3, 3, 5, 10B, 11P, 15, 15A, 26, 26D



KATARA (KTL)

US-11P, 15, 26, 26D
(SmartKey only)

Contemporary deadbolts can be found on page 161

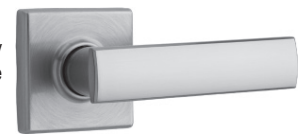

VEDANI (VDL)

US-11P, 15, 26, 26D
(SmartKey only)

Function	No.	Operation
PASSAGE/HALL/CLOSET	720	Both levers always free.
PRIVACY/BED/BATH	730	Both levers locked or unlocked by turnbutton inside. Outside lever unlocked by emergency key. (KW-81087)
KEYED ENTRY	740	Outside locked or unlocked by key outside or turnbutton inside.
1/2 DUMMY	788	For doors where only a pull is required. Surface mounted.

154 v2
(PL-8)

SUPER SPECIAL PRICING AVAILABLE ON ITEMS MARKED WITH ■ - SUPPLIES LIMITED - PLEASE INQUIRE.

KWIKSET

TOUCHPAD ELECTRONIC LEVER

Kwikset
Signature Series

2 locks per case

SmartCode™ Levers

- One touch locking convenience.
- Installs in minutes with just a screwdriver.
- Requires 4 "AA" alkaline batteries (not included).
- Residential 1-Year Electrical warranty.
- Residential Lifetime Finish & Mechanical warranty.

Electronic Keyless Entry System

- Four customizable access codes for increased security.
- Back-Lit keypad for Increased Visibility.
- Customizable Automatic Door Locking After 30 Seconds for Peace Of Mind.
- Fits Standard Doors (1 3/8"-1 3/4").
- SmartCode™ Lever Ideal for - Small/ Home Office, Utility/Storage Room, Interior Garage/Slide Door.



911 Series
US-LO3, 11P, 15

To Order, Specify:

Function: **911** *Keyed Entry*
Design: **TNL** *Tustin Lever*
Finish: **US-15** *Satin Nickel*
Cylinder: **SMT** *SmartKey*

NOTE: LO3 finish has the Lido Lever, 11P and 15 finishes have the Tustin Lever.

SPECIFICATIONS

DOOR THICKNESS: 1-3/8" to 1-3/4" automatic adjustment
BACKSET: Adjustable to 2-3/8" or 2-3/4" RCAL
BORE: 2-1/8" x 1"
BOLT THROW: 1/2"
CYLINDER: 5 Pin SmartKey® only
FINISHES: **US-LO3** Bright Brass - Lifetime
US-11P Venetian Bronze
US-15 Satin Nickel

RESIDENTIAL & LIGHT COMMERCIAL LEVER

Kwikset

20 locks per case

- ANSI/BHMA Grade 2 Certified.
- Lever functions satisfy 4.13.9 ADA requirement.
- 5-Pin Cylinder
- ADA Turnpiece.



KINGSTON (KNL)
US-3, 5, 15A, 26, 26D



Function	No.	Operation
PASSAGE/HALL/CLOSET	720	Both levers always free.
PRIVACY/BED/BATH	730	Both levers locked or unlocked by ADA turnbutton inside. Outside lever unlocked by emergency key. (KW-81087)
KEYED ENTRY LEVER	740	Both levers locked or unlocked by key outside or ADA turnbutton inside.

To Order, Specify:

Function #: **740** *Keyed Entry*
Design: **KNL** *Kingston*
Finish: **US-26D** *Satin Chrome*
Latch: **6WAL** *6-way Adjustable*

SPECIFICATIONS

DOOR THICKNESS: 1-3/8" to 1-3/4"
BACKSET: 6WAL-Adjustable latch for 2-3/8", 2-3/4" with Square Face/Round Face/Drive-in.
STRIKE: 2-1/4" full lip strike.
BORE: 2-1/8" x 1"
ROSE: 2-5/8"
CYLINDER: 5-pin
KEY BLANK: KW-81063
FINISHES: **US-3** (605) Polished Brass
US-26D (626) Satin Chrome

A limited supply of 200, 300, 400, 405 in US-5, 15A, 26 locks are available at closeout prices. The factory has discontinued these locks.

©ZIPF LOCK COMPANY

SUPER SPECIAL PRICING AVAILABLE ON ITEMS MARKED WITH ■ - SUPPLIES LIMITED - PLEASE INQUIRE.

155_{v1}
(PL-8)

KWIKSET

LEVER LOCKS

- ANSI/BHMA Grade 3 Certified except 488 function.
- Lifetime Mechanical Warranty.
- Lifetime Finish Warranty.

Kwikset

20 locks per case
400 Function 12 locks per case

200, 488 functions satisfy
Section 4.13.9 ADA
requirements



DELTA (DL)
US-3, 5, 15A, **26**, 26D
(300DL also **3x26**)



DORIAN (DNL)
US-3, 5, 11P, 15,
15A, **26**, 26D



SAXTON (SNL)
US-3, 5, 15, 15A, **26**, 26D
(400SNL also **LO3**)
(Specify Hand - LH or RH)

CALL FOR SUPER LOW PRICE
Limited Supply
Discontinued by Factory
Replaced by TNL on page 154

Keyed Levers

are available in 405,
406, 462 functions.
Limited finish availability.

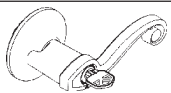

400 FUNCTION HAS COPA KNOB ON THE OUTSIDE
EXCEPT FOR 11P & 15 FINISH WHICH HAS THE
CAMERON KNOB



BALBOA (BL)
US-3, 11P, 15

To Order, Specify:

Function: **405** *Keyed Entry Lever*
Design: **DL** *Delta Lever*
Finish: **US-3** *Polished Brass*
Latch: **6WAL** *6-way adjustable*
>>Handing required on Saxton. 488 function on Balboa<<
(SEE BELOW FOR HOW TO DETERMINE HANDING)
See page 160 for details on 6WAL latch.

DOOR THICKNESS:
BACKSET:

BORE:
ROSE:
CYLINDER:
KEY BLANK:
FINISHES:

SPECIFICATIONS

1-3/8" to 1-3/4"
6WAL-Adjustable latch for 2-3/8", 2-3/4"
with Square Face/Round Face/Drive-in.
Balboa has RCAL only.
2-1/8" x 1"
2-5/8"
5-pin
KW-81063
US-3 (605) Polished Brass
US-5 (609) Antique Brass
US-11P Venetian Bronze
US-15 (619) Satin Nickel
US-15A (620) Antique Nickel
US-26 (625) Polished Chrome
US-26D (626) Satin Chrome

Function	No.	Operation
PASSAGE/HALL/CLOSET	200	Both levers always free.
PRIVACY/BED/BATH	300	Both levers locked or unlocked by turnbutton inside. Outside lever unlocked by emergency key. (KW-81087)
ENTRY	400	Both sides locked or unlocked by key outside or turnbutton inside.
KEYED ENTRY LEVER	405	Both levers locked or unlocked by key outside or turnbutton inside.
KEYED ENTRY LEVER	406	Outside lever locked or unlocked by key outside or turnbutton inside. Inside always free.
STOREROOM/VESTIBULE	462	Outside lever unlocked only while key is turned. Inside always free. (<i>DL, LL, SNL ONLY</i>)
1/2 DUMMY	488	For doors where only a pull is required. Surface mounted.

HOW TO DETERMINE THE HANDING OF A DOOR:

- The hand of a door is always determined by facing the OUTSIDE of a door.
- If the hinge is on the left side of the door, the door is left handed (LH).
- If the hinge is on the right side of the door, the door is right handed (RH).
- To determine the hand of a dummy lever, face the side of the door it will be used on. If hinges are on left, order L.H., if hinges are on right, order R.H.

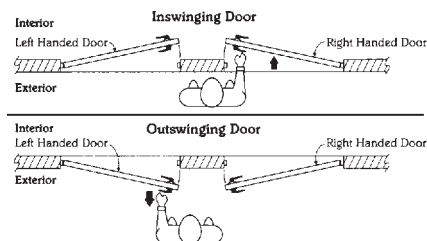

©ZIPF LOCK COMPANY

156v2 SUPER SPECIAL PRICING AVAILABLE ON ITEMS MARKED WITH ■ - SUPPLIES LIMITED - PLEASE INQUIRE.
(PL-8)

KWIKSET

Kwikset

30 locks per case
Dummy - 20 locks per case

KNOB LOCKS

- ANSI/BHMA Grade 3 Certified except 488 function.
- Lifetime Mechanical Warranty.
- Lifetime Finish Warranty.



TYLO (T)
US-3, 5, 26, 26D
(300T also 3x26, 5x26)

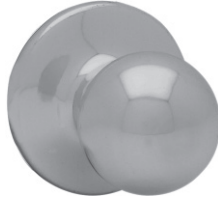

POLO (P)
US-3, 5, 11P, 15, 15A, 26, 26D
(300P also 5x26)



COVE (CV)
US-3, 11P, 26D
(SmartKey available)



BELAIR (B)
US-3, 5
(300B also 3x26)

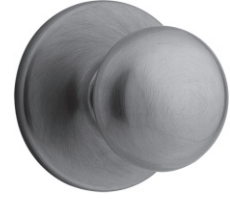

VALIANT (V)
US-3, 15
(300V also 3x26)

These locks are discontinued by the factory.
There is a limited supply left **AT GREAT CLOSEOUT PRICES.**

To Order, Specify:

Function : **400** *Keyed Entry*
Design: **T** *Tylo*
Finish: **US-3** *Polished Brass*
Latch: **6WAL** *6-way Adjustable*

See page 160 for details on 6WAL latch.

SPECIFICATIONS

DOOR THICKNESS: 1-3/8" to 1-3/4"
***BACKSET:** 6WAL-Adjustable latch for 2-3/8", 2-3/4" with Square Face/Round Face/Drive-in. SCS, RCS
***STRIKE:** SCS, RCS
*Selection may be limited.
BORE: 2-1/8" x 1"
ROSE: 2-5/8"
CYLINDER: 5-pin. 5 pin SmartKey also available in Cove design.
KEY BLANK: KW-81063
FINISHES:

US-3 (605)	Polished Brass
US-5 (609)	Antique Brass
US-11P	Venetian Bronze
US-15 (619)	Satin Nickel
US-15A (620)	Antique Nickel
US-26 (625)	Polished Chrome
US-26D (626)	Satin Chrome

BUMPGUARD™
Patented side locking bar technology replaces a traditional pin & tumbler design to protect against lock bumping.

DRILL RESISTANCE
Cylinder uses two steel balls inserted into the front of the key face to resist attack from drilling.

NEW TECHNOLOGY
Locking bar, racks and pins are made out of stainless steel for increased strength and durability.

KEY IT YOURSELF
Lock is rekeyable by using the included learn tool in less than 30 seconds without removing the lock from the door.

See page 172 for "How to re-key a SmartKey cylinder"

Function	No.	Operation
PASSAGE/HALL/CLOSET	200	Both knobs always free.
PRIVACY/BED/BATH	300	Both knobs locked or unlocked by turnbutton inside. Outside knob unlocked by emergency key. (KW-81087)
PRIVACY/BATHROOM	300	Same function as 300 above. Inside knob polished chrome. (Discontinued)
ENTRY	400	Both knobs locked or unlocked by key outside or turnbutton inside.
ENTRY	401	Outside knob locked or unlocked by key outside or turnbutton inside. Inside always free. (Polo and Tylo designs in US-3 only)
1/2 DUMMY	488	For use on door where only a pull is required. Surface mounted.

©ZIPF LOCK COMPANY

SUPER SPECIAL PRICING AVAILABLE ON ITEMS MARKED WITH ■ - SUPPLIES LIMITED - PLEASE INQUIRE.

157_{v2}
(PL-8)

KWIKSET

980S SERIES DEADBOLTS

- ANSI/BHMA Grade 1 Certified.
- Titanium Alloy Throwbolt Core.
- Ultra-Strike Door Jamb Brace.
- Solid Steel Latch Face.
- Anti-Pick 6-pin Cylinder.
- Lifetime Mechanical Warranty.
- Lifetime Finish Warranty.

Kwikset
Signature Series

12 locks per case.

Interior turnpiece meets
4.13.9 ADA requirements



980S Single Cylinder

US-LO3, 5, 11P, 15, 15A, 26, 26D

985S Double Cylinder

US-LO3, 5, 11P, 15, 15A, 26, 26D, 514

DOOR THICKNESS:	SPECIFICATIONS
BACKSET:	1-3/4"
STRIKE:	Adjustable for 2-3/8", 2-3/4" with round corner face
BORE:	1-1/4" x 3-5/8" round corner
CYLINDER:	2-1/8" or 1-1/2" x 1"
KEY BLANK:	6-pin, includes 3 anti-pick pins
FINISHES:	KW-81208 (KW-88260)
	US-LO3 (605E) Polished Brass-Lifetime
	US-5 (609) Antique Brass
	US-11P Venetian Bronze
	US-15 (619) Satin Nickel
	US-15A (620) Antique Nickel
	US-26 (625) Polished Chrome
	US-26D (626) Satin Chrome
	US-514 Iron Black

No.	Description
980S	Single Cylinder: Deadbolt operated by key outside or thumbturn inside.
985S	Double Cylinder: Deadbolt operated by key both sides.

To Order, Specify:

Function: **980S** *Single Cylinder*
Finish: **US-11P** *Venetian Bronze*

*Latch: **RCAL** *Adjustable*

*2-3/8" or 2-3/4" adjustable deadbolt Round Corner latch.

780 SERIES DEADBOLTS

- ANSI/BHMA Grade 2 Certified.
- Maximum Security, Heavy Gauge Strike with Extra Long 3" Screws.
- Compatible with Kwikset's 5 Pin Keying Systems.
- Lifetime Mechanical Warranty.
- Lifetime Finish Warranty.

Kwikset
Signature Series

12 locks per case.



Interior turnpiece meets
4.13.9 ADA requirements



780 Single Cylinder

US-LO3, 3, 5, 11P, 15, 15A, 26, 26D

785 Double Cylinder

US-LO3, 3, 5, 11P, 15, 15A, 26, 26D

SmartKey available on 780 US-3, 11P and 15.
See previous page for information on the SmartKey.

DOOR THICKNESS:	SPECIFICATIONS
BACKSET:	1-3/8" to 1-3/4"
BORE:	Adjustable for 2-3/8", 2-3/4"
CYLINDER:	2-1/8" or 1-1/2" x 1"
KEY BLANK:	6-pin. 5 pin SmartKey available on 780 US-3, 11P and 15.
FINISHES:	KW-81208 (KW-88260)
	US-LO3 (605E) Polished Brass-Lifetime
	US-3 (605) Polished Brass
	US-5 (609) Antique Brass
	US-10B (613) Oil Rubbed Bronze
	US-11P Venetian Bronze
	US-15 (619) Satin Nickel
	US-15A (620) Antique Nickel
	US-26 (625) Polished Chrome
	US-26D (626) Satin Chrome

No.	Description
780	Single Cylinder: Deadbolt operated by key outside or thumbturn inside.
785	Double Cylinder: Deadbolt operated by key both sides.

To Order, Specify:

Function: **780** *Single Cylinder*

Finish: **US-3** *Polished Brass*

*Latch: **SCAL** *Adjustable Latch*

*2-3/8" or 2-3/4" adjustable deadbolt latch is standard.

Specify **RCAL** for Round Corner Adjustable Latch.

Specify **SCAL** for Square Corner Adjustable Latch.

Specify **RFAL** for Round Face Adjustable Latch.

©ZIPF LOCK COMPANY

158 v2 SUPER SPECIAL PRICING AVAILABLE ON ITEMS MARKED WITH ■ - SUPPLIES LIMITED - PLEASE INQUIRE.
(PL-8)

KWIKSET

Kwikset

2 locks per case.

TOUCHPAD ELECTRONIC DEADBOLT

Powerbolt Deadbolts

- 1" projection deadbolt latch with 1/4" diameter hardened steel free-turning roller.
- Easy to Install, Easy to Program, Easy to Use.
- Requires 4 "AA" alkaline batteries (not included).
- 1-Year Electronic warranty.
- Lifetime Mechanical warranty.
- Lifetime Finish warranty.

Electronic Keyless Entry System

- Simply enter your personalized access code for convenient, quick and care-free entry.
- You may also program a temporary second code for a neighbor, cleaning crew, etc.
- Alarm sounds after 3 consecutive incorrect codes are entered.
- Easy-one touch locking.
- Heavy duty security deadbolt and strike plate resist break-ins.
- No wiring necessary (add 4 Alkaline "AA" batteries).
- Low battery indicator.
- Fits standard preparation on new doors.
- Easily replaces existing door hardware.



907 Series
US-LO3,11P, 15

SPECIFICATIONS

DOOR THICKNESS:	1-3/8" to 2"
BACKSET:	Adjustable 2-3/8" to 2-3/4" RCAL
BORE:	2-1/8" x 1"
BOLT THROW:	1"
CYLINDER:	5 Pin SmartKey® only
FINISHES:	US-LO3 Bright Brass - Lifetime US-11P Venetian Bronze US-15 Satin Nickel

To Order, Specify:

Function: **907** *Single Cylinder*
Finish: **US-15** *Satin Nickel*
Cylinder: **SMT** *SmartKey*

Stock No. Operation

907 **Single Cylinder Deadbolt-**

Deadbolt latch retracted by entering security code outside and extended by pushing lock button outside. Deadbolt latch extended and retracted by T-Turn on inside. Using key outside will retract deadbolt latch if needed.

TOUCHPAD ELECTRONIC DEADBOLT

SmartCode™ Deadbolts

- Lock your door with a touch of a button.
- Installs in minutes with just a screwdriver.
- Requires 4 "AA" alkaline batteries (not included).
- 1 Year Electronic warranty.
- Lifetime Finish & Mechanical warranty.

Electronic Keyless Entry System

- Two customizable codes - one code for family, one code for temporary access.
- Back-Lit keypad for Increased Visibility.
- One touch locking with a motorized deadbolt.
- Fits Standard Doors (1 3/8"-1 3/4").
- SmartCode™ Deadbolt replaces any deadbolt for Keyless Entry convenience.

To Order, Specify:

Function: **909** *Single Cylinder*
Finish: **US-15** *Satin Nickel*
Cylinder: **SMT** *SmartKey®*



909 Series
US-LO3,11P, 15

2 locks per case.

Stock No. Operation

909 **Single Cylinder Deadbolt-**

Deadbolt latch retracted by entering security code outside and extended by pushing lock button outside. Deadbolt latch extended and retracted by T-Turn on inside. Using key outside will retract deadbolt latch if needed.

SPECIFICATIONS

DOOR THICKNESS:	1-3/8" to 1-3/4" automatic adjustment
BACKSET:	Adjustable to 2-3/8" or 2-3/4" RCAL
BORE:	2-1/8" x 1"
BOLT THROW:	1"
CYLINDER:	5 Pin SmartKey® only
FINISHES:	US-LO3 Bright Brass - Lifetime US-11P Venetian Bronze US-15 Satin Nickel

©ZIPF LOCK COMPANY

KWIKSET

660 SERIES DEADBOLTS

- ANSI/BHMA Grade 3 Certified.
- Lifetime Mechanical Warranty.
- Lifetime Finish Warranty.

SmartKey® available on:

660 US-3, 11P, 15
665 US-3

Kwikset
The Beauty of Strength™

12 locks per case.

Interior turnpiece meets
4.13.9 ADA requirements



660 Single Cylinder
US-3, 5, 11P, 15, 15A, 26D



665 Double Cylinder
US-3, 5, 11P, 15, 15A, 26D

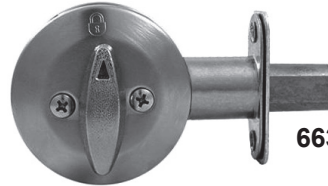

663 One Sided (Pictured)
US-3, 5, 15, 15A, 26D

667 One Sided w/Exterior Plate
US-3, 26D

No. Description

- 660 Single Cylinder:** Deadbolt operated by key outside and thumbturn inside.
- 663 Thumbturn Only:** Deadbolt operated by thumbturn one side. No trim on other side.
- 665 Double Cylinder:** Deadbolt operated by key both sides.
- 667 Thumbturn x Plate:** Deadbolt operated by thumbturn on interior. Blank plate on exterior.

SPECIFICATIONS

DOOR THICKNESS:	1-3/8" to 1-3/4"														
BACKSET:	Adjustable for 2-3/8", 2-3/4" 663 has 2-3/8" fixed latch														
STRIKE:	1" x 2-1/4"														
BORE:	2-1/8" x 1" 1-5/8" x 1" (For 663 Lock) 2-1/8" or 1-1/2" x 1" (For 667 Lock)														
CYLINDER:	5-pin														
KEY BLANK:	KW-81063														
FINISHES:	<table border="0"> <tr> <td>US-3 (605)</td> <td>Polished Brass</td> </tr> <tr> <td>US-5 (609)</td> <td>Antique Brass</td> </tr> <tr> <td>US-11P</td> <td>Venetian Bronze</td> </tr> <tr> <td>US-15 (619)</td> <td>Satin Nickel</td> </tr> <tr> <td>US-15A (620)</td> <td>Antique Nickel</td> </tr> <tr> <td>US-26 (625)</td> <td>Polished Chrome</td> </tr> <tr> <td>US-26D (626)</td> <td>Satin Chrome</td> </tr> </table>	US-3 (605)	Polished Brass	US-5 (609)	Antique Brass	US-11P	Venetian Bronze	US-15 (619)	Satin Nickel	US-15A (620)	Antique Nickel	US-26 (625)	Polished Chrome	US-26D (626)	Satin Chrome
US-3 (605)	Polished Brass														
US-5 (609)	Antique Brass														
US-11P	Venetian Bronze														
US-15 (619)	Satin Nickel														
US-15A (620)	Antique Nickel														
US-26 (625)	Polished Chrome														
US-26D (626)	Satin Chrome														

KW-664 Conversion Kit US-5, 26D

To convert a 663 to a 667. Kit has Exterior Plate, screws and torque blade. (Discontinued - call for price)

To Order, Specify:

Function: **665 Double Cylinder**
Finish: **US-3 Polished Brass**
*Latch: **SCAL Adjustable Latch**
*2-3/8" or 2-3/4" adjustable deadbolt latch is standard. Specify **RCAL** for Round Corner Adjustable Latch. Specify **SCAL** for Square Corner Adjustable Latch. Specify **RFAL** for Round Face Adjustable Latch.

COMBO PACKS

6 locks per case.

- ANSI/BHMA Grade 3 Certified.
- Lifetime Mechanical Warranty.
- Lifetime Finish Warranty.
- 5-Pin Cylinder.
- Key Blank: KW-81063

Kwikset

Contains:

- 1 single cylinder deadlock (660) and 1 entry lock (400T), keyed alike.
- Adjustable latches— 2-3/8" or 2-3/4"
- Round Corner Strikes (RCS).
- Sets available Keyed in 2's (KA-2)



690T 3 6AL
Tylo in
Polished Brass

6-WAY UNIVERSAL LATCH For Kwikset Knob & Lever Locks

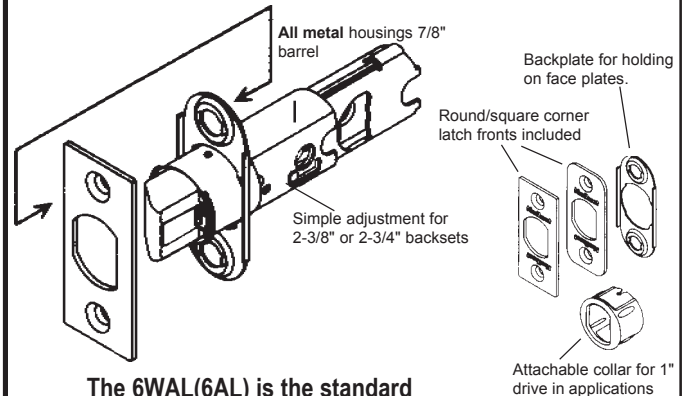

The 6WAL(6AL) is the standard latch for most knob and lever locks.

©ZIPF LOCK COMPANY

160v2 SUPER SPECIAL PRICING AVAILABLE ON ITEMS MARKED WITH ■ - SUPPLIES LIMITED - PLEASE INQUIRE.
(PL-8)

KWIKSET

KEY CONTROL™ DEADBOLTS

Kwikset
Signature Series

12 locks per case.

Featuring SmartKey® Re-Key Technology

- ANSI/BHMA Grade 2 Certified.
- The smart alternative to master keying.
- Interior turn piece meets 4.13.9 ADA requirements.
- Lifetime Mechanical Warranty.
- Lifetime Finish Warranty.

Key Control -

- Top concealed cylinder provides one-key control for the property manager.
- Lower exposed cylinder allows unique user keys for the tenant.
- Re-key your user or control cylinder at any time in seconds.
- Maintain key control throughout tenant and employee turnover.

Increased Efficiency

- Re-key the lock without removing from the door.



816 Single Cylinder
US-3, 5, 15, 26D

SPECIFICATIONS

DOOR THICK.: 1-3/4"

BACKSET: Adjustable for 2-3/8", 2-3/4" with Round Corner Face

STRIKE: RCL

BORE: 2-1/8" x 1"

CYLINDER: 5 Pin SmartKey®

KEY BLANK: SmartKey(user) Secure SmartKey
KW-81063 KW-83362

FINISHES: **US-3** (605) Polished Brass
US-5 (609) Antique Brass
US-15 (619) Satin Nickel
US-26D (626) Satin Chrome

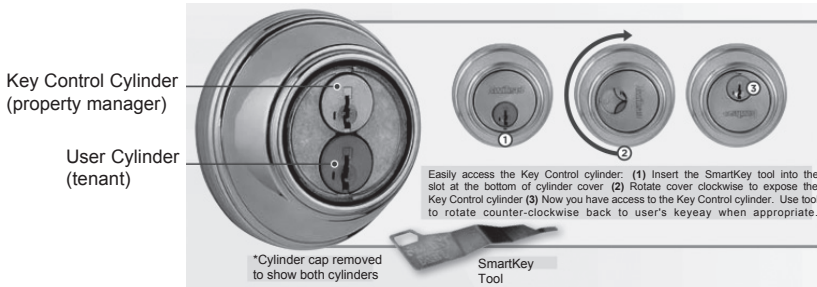

CONTEMPORARY DEADBOLT

Kwikset
Signature Series

12 locks per case.

- ANSI/BHMA Grade 2 Certified.
- Lifetime Mechanical Warranty.
- Lifetime Finish Warranty.

SPECIFICATIONS

DOOR THICKNESS: 1-3/8" to 1-3/4"

BACKSET: Adjustable latch for 2-3/8", 2-3/4" with Round Corner Face

STRIKE: RCS

BORE: 2-1/8" x 1"

CYLINDER: 5 Pin SmartKey®

KEY BLANK: KW-81063

FINISHES: **US-11P** Venetian Bronze | **US-26** (625) Polished Chrome
US-15 (619) Satin Nickel | **US-26D** (626) Satin Chrome

Contemporary Levers
locks can be found on
page 154



Round Deadbolt
993RDT Single Cylinder
US-11P, 15, 26, 26D



Square Deadbolt
993SQT Single Cylinder
US-11P, 15, 26, 26D

POCKET DOOR LOCKS

Kwikset
The Beauty of Strength™

12 locks per case.

Round Pocket Door Lock

- Fits standard 2-1/8" prep.
- Installs in minutes.
- Auto Catch Lock Mechanism.
- Lifetime Mechanical Warranty.
- Lifetime Finish Warranty.

Stock No. Description

KW-334 Passage

KW-335 Privacy

Specify Stock No. and Finish.

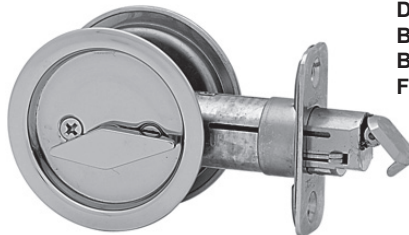

SPECIFICATIONS

DOOR THICK.: 1-3/8" to 1-3/4"

BACKSET: 2-3/8"

BORE: 2-1/8" x 1"

FINISHES: **US-3** (605) Polished Brass
US-5 (609) Antique Brass
US-10B (613) Oil Rubbed Bronze
US-15 (619) Satin Nickel
US-15A (620) Antique Nickel
US-26D (626) Satin Chrome
US-32 (629) Bright Stainless Steel

©ZIPF LOCK COMPANY

KWIKSET

800 SERIES SOLID BRASS ENTRANCE HANDLESETS

- ANSI/BHMA Grade 1 Deadbolt.
- Extra Large Interior Turnpiece for Easier Locking and Unlocking.
- SmartKey® Re-Key technology with BumpGuard™
- Maximum Security, Heavy Gauge Deadbolt Strike with Extra Long 3" Screws.
- Lifetime Mechanical Warranty.
- Lifetime Finish Warranty.

Kwikset
Signature Series

6 locks per case.

To Order, Specify:

For handle-(exterior only)

Handle No.: **800AN** *Arlington*
 Finish: **US-15** *Satin Nickel*
 Int. Pack **LIP** *Less Interior Pack*
 Latch: **RCAL** *Round Corner Adjustable*

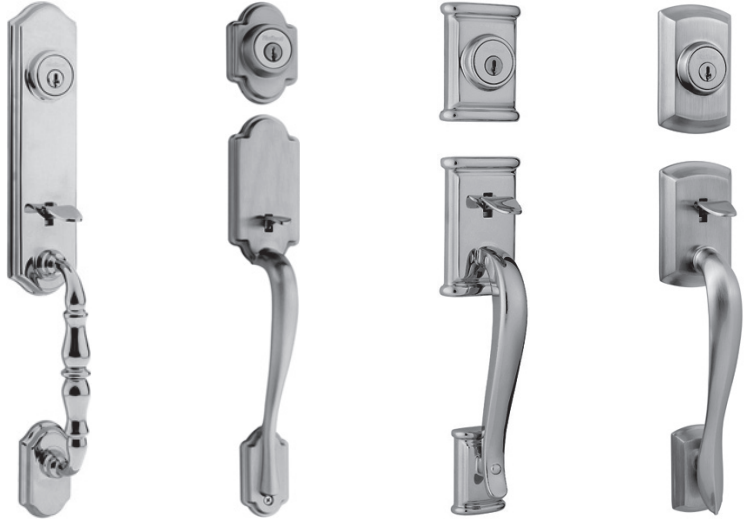

FUNCTIONS:
 Locking Handle
 Dummy Handle

AMHERST
800AT
802AT

ARLINGTON
800AN
802AN

ASHFIELD
800ADH
802ADH

AVALON
800AVH
802AVH

US-LO3, 11P,
 15, 15A, 26

US-LO3, 3, 5,
 11P, 15, 15A, 26

US-LO3, 11P, 15,
 514

US-LO3, 11P, 15,
 514

Distance from center of handle
 hole to bottom mounting screw:

Amherst: 8-13/32"
 Arlington: 11"
 Ashfield: 8-13/32"
 Avalon: 8-13/32"
 Chelsea: 9-11/16"
 Hawthorne: 8-13/32"
 Shelburne: 8-13/32"
 Sheridan: 11"
 Tavaris: 8-13/32"
 Wellington: 8-13/32"



CHELSEA
800CE
802CE

US-LO3, 3, 5, 11P,
 15, 15A, 26, 26D

HAWTHORNE
800HE
802HE

US-11P, 15,
 15A, 26, 26D

SHELBURNE
800SE
802SE

US-LO3, 5, 11P,
 15, 26

SHERIDAN
800SN
802SN

US-LO3, 3, 11P,
 15, 15A, 26, 26D

TAVARIS
800TVH

--
 US-11P, 15,
 26, 26D

WELLINGTON
800WN
802WN

US-11P, 15, 15A,
 26

Old Society
 Brass Numbers

Old Number	New Number
840	802WN
841	800WN
855	802HE
858	800HE
877	802AT
878	800AT
881	802SE
884	800SE

Factory has discontinued. Call for closeout prices.

800-Locking Exterior Handle
 802-Dummy Exterior Handle

See next page for interior designs available for 800 Series handlesets.

162_{v2}
 (PL-8)

HANDLE PACK CONTAINS: Handle, keys, latches, strikes, outside deadbolt, screw pack.
INTERIOR PACK CONTAINS: 1 knob or lever, 1 thumbturn for deadlock, screw pack.
SUPER SPECIAL PRICING AVAILABLE ON ITEMS MARKED WITH ■ - SUPPLIES LIMITED - PLEASE INQUIRE.

KWIKSET

800 SERIES ENTRANCE HANDLESETS INTERIORS

- Lifetime Mechanical warranty.
- Lifetime Finish warranty.

Kwikset
Signature Series

6 interiors per case.

SIGNATURES INTERIOR DESIGNS (SOLD SEPARATELY FROM HANDLES)



CIRCA (CA)
US-3, 10B, 11P,
15, 15A, 26, 26D



HANCOCK (H)
US-3, 5, 10B, 11P,
15, 15A, 26, 26D



COPA (C)
US-3, 5, 15, 15A



ABBEY (A)
US-3, 5, 26D



LAUREL (L)
US-5, 10B, 11P, 15,
15A



CAMERON (CN)
US-3, 11P, 15



KATARA (KTL)
US-11P, 15, 26, 26D
(Specify Hand)

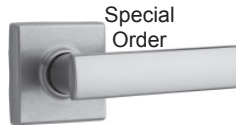

VEDANI (VDL)
US-11P, 15, 26, 26D



COMMONWEALTH (CHL)
US-3, 5, 10B, 11P,
15, 15A, 26, 26D
(Specify Hand)



PEMBROKE (PML)
US-15, 26
(Specify Hand)



LIDO (LL)
US-3, 5, 11P, 15,
15A, 26, 26D
(Specify Hand)



TUSTIN (TNL)
US-3, 5, 11P, 15, 15A,
26, 26D
(Specify Hand)



ASHFIELD (ADL)
US-3, 11P, 15, 514



AVALON (AVL)
US-3, 11P, 15, 514
(Specify Hand)



BROOKLANE (BRL)
US-5, 10B, 11P, 15,
15A, 26, 26D
(Specify Hand)

KWIKSET INTERIOR DESIGNS FOR USE WITH SIGNATURE HANDLESETS (SOLD SEPARATELY FROM SIGNATURE HANDLES)

- Lifetime Mechanical warranty
- Lifetime Finish warranty



DELTA (DL)
US-3, 5, 15A, 26, 26D



DORIAN (DNL)
US-3, 5, 11P, 15, 15A, 26, 26D

SAXTON-Limited Supply
Discontinued by Factory.
Call for closeout prices.
Replaced by TNL above.



SAXTON (SNL)
US-3, 5, 15A, 26, 26D
(Specify Hand)

Kwikset

SPECIFICATIONS

DOOR THICKNESS: 1-3/4"
BACKSET: Adjustable Round Corner (RCAL)
2-1/8" x 1"
BORE: 2-1/8" or 1-1/2" x 1" (Deadbolt)
SPACING: 5-1/2" center to center. For handle hole
to bottom mounting screw see previous page.
DEADBOLT: 980, 1" throw.
CYLINDER: 5 pin SmartKey only.
KEY BLANK: KW-81063

FINISHES: **US-LO3** (605E) Polished Brass-Lifetime
US-3 (605) Polished Brass
US-5 (609) Antique Brass
US-10B (613) Oil Rubbed Bronze
US-11P Venetian Bronze
US-15 (619) Satin Nickel
US-15A (620) Antique Nickel
US-26 (625) Polished Chrome
US-26D (626) Satin Chrome
US-514 Iron Black

See previous page for 800 Series handleset exteriors.

©ZIPF LOCK COMPANY

SUPER SPECIAL PRICING AVAILABLE ON ITEMS MARKED WITH ■ - SUPPLIES LIMITED - PLEASE INQUIRE.

163_{v2}
(PL-8)

KWIKSET

500 SERIES SOLID BRASS HANDLESETS

- ANSI/BHMA Grade 1 Deadbolt for Gibson Handleset.
- ANSI A156.5 Grade 2 for Sonoma Deadbolt.
- Lifetime Mechanical Warranty.
- Lifetime Finish Warranty for Gibson.

Kwikset
Signature Series



SONOMA
Locking **510SO**
Dummy **512SO**

US-LO3, 3, 15, 15A, 26



GIBSON
Locking **553GN**
Dummy **555GN**

US-LO3, 3, 5, 15

6 locks per case.

Interior Packs

For: **Sonoma Gibson**
Locking **471 986**
Dummy **473 989**

To Order, Specify:

For handle-(exterior only)

Handle No.: **553GN** Gibson
Finish: **US-3** Polished Brass
Less Int. Pack **LIP** Less Interior Pack
Latch: **RCAL** Round Corner adj.

For interior pack-

Interior No.: **986**
Design: **LL** Lido Lever
Finish: **US-3** Polished Brass
Handing: **LH*** Left Hand

*Required on lever designs
LL & SNL (LH or RH)

•ALL HANDLES ARE SOLD LESS INTERIOR PACK (YOU MUST ORDER SEPARATELY)•

INTERIOR DESIGNS (SOLD SEPARATELY FROM HANDLES)



BELAIR (B)
US-3



CAMERON (CN)
US-3, 5, 11P, 15, 15A, 26



COPA (C)
US-3, 5, 15A, 26, 26D



COVE (CV)
US-3



DELTA (DL)
US-3, 5, 15A, 26, 26D



DORIAN (DNL)
US-3, 5, 15, 15A, 26, 26D



LIDO (LL)
US-3, 5, 15, 15A, 26, 26D
(Specify Hand)



POLO (P)
US-3, 5, 15, 15A, 26, 26D

SAXTON-Limited Supply
Discontinued by Factory
Replaced by



SAXTON (SNL)
US-3, 5, 15, 15A, 26, 26D
(Specify Hand)



TUSTIN (TNL)
US-3, 5, 11P, 15, 15A
(Specify Hand)



VALIANT (V)
US-3, 15



TYLO (T)
US-3, 5, 26, 26D

SPECIFICATIONS

DOOR THICKNESS: 1-3/4"
BACKSET: Adjustable Round Corner (RCAL)
BORE: 2-1/8" x 1"
2-1/8" or 1-1/2" x 1" (Deadbolt)
SPACING: 5-1/2" center to center
9-11/16" from handle hole to bottom mounting screw.
DEADBOLT: 1" throw
CYLINDER: 5-Pin SmartKey® only
KEY BLANK: KW-81063
FINISHES:
US-LO3 (605E) Polished Brass-Lifetime
US-3 (605) Polished Brass
US-5 (609) Antique Brass
US-11P Venetian Bronze
US-15 (619) Satin Nickel
US-15A (620) Antique Nickel
US-26 (625) Polished Chrome
US-26D (626) Satin Chrome

HOW TO DETERMINE THE HANDING OF A DOOR:

- The hand of a door is always determined by facing the OUTSIDE of a door.
- If the hinge is on the left side of the door, the door is left handed (LH).
- If the hinge is on the right side of the door, the door is right handed (RH).

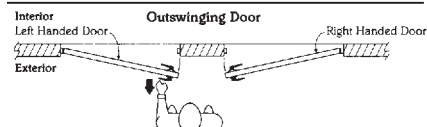
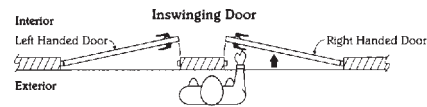

©ZIPF LOCK COMPANY

164_{v2}
(PL-8)

HANDLE PACK CONTAINS: Handle, keys, latches, strikes, outside deadbolt
INTERIOR PACK CONTAINS: 1 knob or lever, 1 thumbturn for deadlock, inside sex bolt for handle bottom.
SUPER SPECIAL PRICING AVAILABLE ON ITEMS MARKED WITH ■ - SUPPLIES LIMITED - PLEASE INQUIRE.

KWIKSET

600 SERIES STANDARD DUTY HANDLESETS

- ANSI/BHMA Grade 3 Certified Deadbolt
- Lifetime Mechanical Warranty.
- Lifetime Finish Warranty.

Kwikset
The Beauty of Strength™



FUCTION
Locking
Dummy

BELLEVIEW
687BW
699BW
US-3, 5, 11P, 15

DAKOTA
687DA
699DA
US-3, 5, 11P, 15,
15A, 26D

6 locks per case.

Interior Packs

- 604 For Locking
- 606 For Dummy

To Order, Specify:

For handle-(exterior only)

Handle No.: **687DA**
Finish: **US-3**
Less Int. Pack **LIP**
Latch: **RCAL**

For interior pack-

Interior No.: **604**
Design: **LL**
Finish: **US-3**
Handing: **LH***

*Required on lever designs
BL, LL, SNL, TNL (LH or RH)

•ALL HANDLES ARE SOLD LESS INTERIOR PACK (YOU MUST ORDER SEPARATELY)•

INTERIOR DESIGNS (SOLD SEPARATELY FROM HANDLES)



BELAIR (B)
US-3



COPA (C)
US-3, 5, 15, 15A, 26



DELTA (DL)
US-3, 5, 15A, 26, 26D



DORIAN (DNL)
US-3, 5, 11P, 15,
15A, 26, 26D



ECLIPSE (E)
US-3



LIDO (LL)
US-3, 15, 15A, 26, 26D
(Specify Hand)

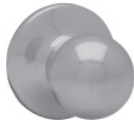

POLO (P)
US-3, 5, 11P, 15, 15A, 26, 26D



SAXTON (SNL)
US-3, 5, 15, 26, 26D
(Specify Hand)

SAXTON-Limited Supply
Discontinued by Factory
Replaced by TNL at right



TUSTIN (TNL)
US-3, 5, 11P, 15, 15A, 26D
(Specify Hand)



VALIANT (V)
US-3



TYLO (T)
US-3, 5, 26, 26D

SPECIFICATIONS

- DOOR THICKNESS:** 1-3/4"
BACKSET: Adjustable Round Corner (RCAL)
BORE: 2-1/8" x 1" (Deadbolt 2-1/8" or 1-1/2")
SPACING: 5-1/2" center to center.
8-13/32" from handle hole to bottom mounting screw.
DEADBOLT: 1" throw
CYLINDER: 5-Pin
KEY BLANK: KW-81063
FINISHES:

- US-3 (605)** Polished Brass
- US-5 (609)** Antique Brass
- US-11P** Venetian Bronze
- US-15 (619)** Satin Nickel
- US-15A (620)** Antique Nickel
- US-26 (625)** Polished Chrome
- US-26D (626)** Satin Chrome



BALBOA (BL)
US-3, 5, 11P, 15, 26D
(Specify Hand)



CAMERON (CN)
US-3, 11P, 15, 15A



COVE (CV)
US-3, 11P, 15

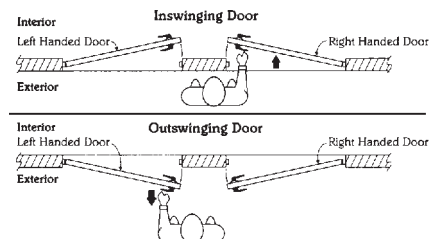

©ZIPF LOCK COMPANY

HANDLE PACK CONTAINS: Handle, keys, latches, strikes, outside deadbolt/rose.
INTERIOR PACK CONTAINS: 1 knob or lever, 1 thumbturn for deadlock, deadlock screws.
SUPER SPECIAL PRICING AVAILABLE ON ITEMS MARKED WITH ■ - SUPPLIES LIMITED - PLEASE INQUIRE.

165_{v2}
(PL-8)

KWIKSET

Kwikset
The Beauty of Strength.

STRIKES FOR:

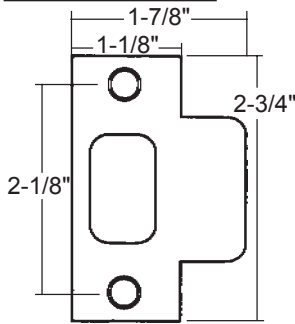

KW-83028 US-3, 26D
Metal Jamb Strike (TMS)
Not available on deadlocks

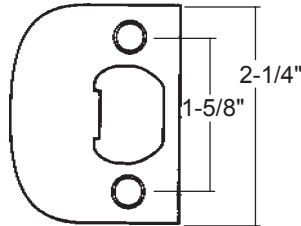

KW-83437
US-3, 5, 10B, 15, 15A
Standard Lockset Strike

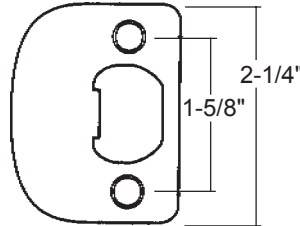

KW-83796
US-3, 5, 10B, 15, 26D
1/4" Radius Strike (RCS-4)

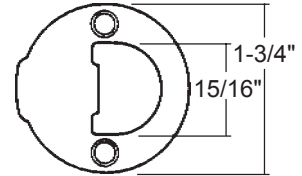

KW-83929 US-3, 5
Full round 1-3/4" metal jamb strike (includes metal and wood screws)

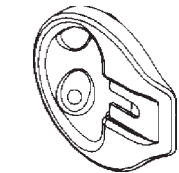
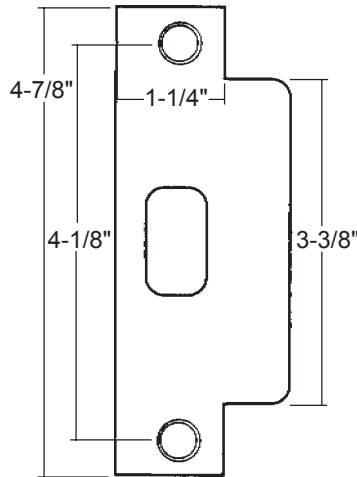

KW-80318 US-3, 5, 26D
Full round adjustable strike.

KW-83846 US-3, 26D
Metal Jamb Strike
1-1/4" x 4-7/8" ANSI
Not available on deadlocks

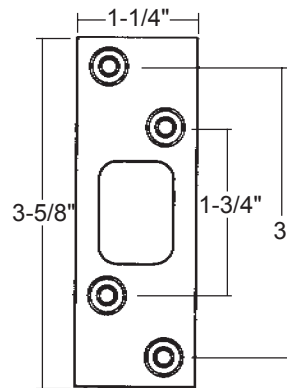

KW-83222
US-3, 5, 10B, 15, 15A, 26D
780, 785, 970, 975, 980, 985

KW-83223 (Radius Corner)
US-5, 10B, 15A
780, 785, 970, 975, 980, 985

FINISHES:

US-3 (605)	Polished Brass
US-LO3 (605E)	Polished Brass-Life
US-5 (609)	Antique Brass
US-10B (613)	Oil Rubbed Bronze
US-15(619)	Satin Nickel
US-15A (620)	Antique Nickel
US-26 (625)	Polished Chrome
US-26D (626)	Satin Chrome

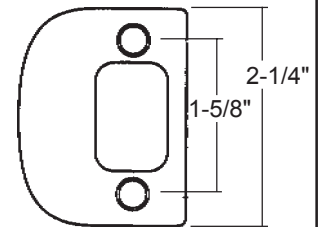

KW-84638 US-3, 26D
Deadbolt strike with lip

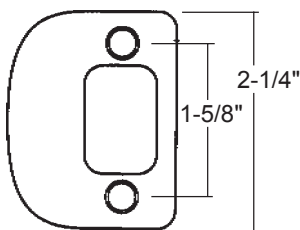

KW-85303 US-10B, 15
Deadbolt strike with lip. 1/4" radius corners.

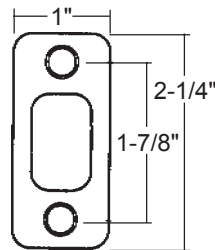

KW-85063
US-3, 5, 15, 15A, 26D
660 Series Deadlock Strike
Round corner strike

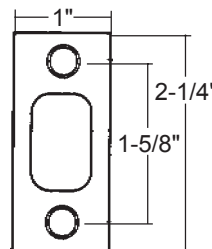

KW-85072
US-3, 15, 15A, 26D
660 Series Deadlock Strike
Square corner strike

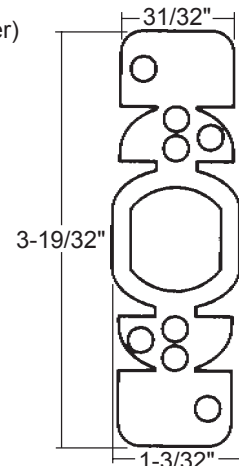

KW-81640 Strike Box
Plastic door jamb deadbolt strike insert for cleaner installation

©ZIPF LOCK COMPANY

KWIKSET

ROSETTES

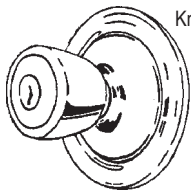

Knobs, pictured, not included.



KW-293 CP
US-3, 5, 15, 26D
Plain Rosette
3-13/16" diameter

KW-239
US-3, 5, 15
Curved Handle

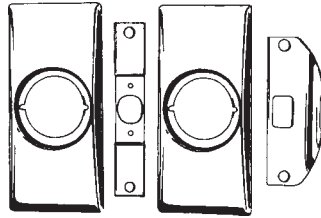

KW-215 US-3
Small Modernization Kit. 7-1/4" x 3-3/8". Includes: 2 small trim plates, (KW-249 below) latch & strike plate.

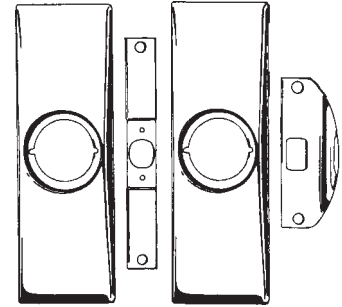

KW-214 US-3
Large Modernization Kit. 3-1/2" x 10-1/2". Includes: 2 large trim plates, latch & strike plate.

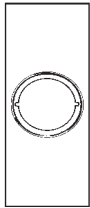

KW-249CP US-3
7-1/4" x 3-3/8" rectangular rosette for 2-3/8" or 2-3/4" backset.

UPGRADE YOUR SIGNATURE SERIES LEVERS

(Sold seperately)



KW-83319 ART
US-11P, 15, 514
Fits all SmartKey, passage, privacy or dummy Signature Series reversible levers.



KW-83318 OVT
US-11P, 15, 514
Fits all SmartKey, passage, privacy or dummy Signature Series reversible levers.

KEYING KITS, PINS, KEYING ACCESSORIES

Kwikset



KW-81467 Cylinder Removing Tool for KW-1850 Cylinders.

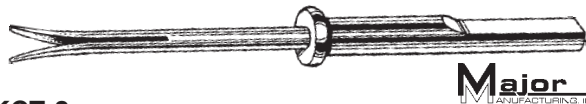

KCT-2
Cylinder tool for Kwikset 400 Series locks. Quickly removes cylinder from lock. Removes cylinder retaining clips. Handle is following tool with master wafer unload feature.



KW-80152 Follower

KW-272 Pin Kit (not pictured)
For Professional keying of Kwikset residential locks. Kit has colored top, master & bottom pins(also anti-pick top pins), PK balls, tumbler springs, 5, 6 & low profile deadbolt pin spring covers, plug retainers, key gauge, plug follower, cylinder removal tool, knob control lug and special cylinder spring.

KW-236 Builder Pin Kit (small-not pictured)

PIN AND SPRING REFILLS FOR KWIKSET:

Descriptions	*Stock #
Tumbler Springs	LB-KW1777
PK Balls	KW-82208
.180 Driver Pin (Top)	LB-KW1858
.180 Regular Anti-pick Pin (Top)	KW-80370
.160 PK Pin (Top)	KW-83117
.160 PK Anti-pick Pin (Top)	KW-80369
.172 Bottom Pin-#1	LB-KW3100
.195 Bottom Pin-#2	LB-KW3101
.218 Bottom Pin-#3	LB-KW3103
.241 Bottom Pin-#4	LB-KW3105
.264 Bottom Pin-#5	LB-KW3106
.287 Bottom Pin-#6	LB-KW3107
.023 Master Pin-#1	LB-KW3108
.046 Master Pin-#2	LB-KW3110
.069 Master Pin-#3	LB-KW3112
.092 Master Pin-#4	LB-KW3113
.115 Master Pin-#5	LB-KW3114
.138 Master Pin-#6	LB-KW3125
*LB- made by LAB.	



KW-20622
Steel learning tool for SmartKey® cylinders.

©ZIPF LOCK COMPANY

SUPER SPECIAL PRICING AVAILABLE ON ITEMS MARKED WITH ■ - SUPPLIES LIMITED - PLEASE INQUIRE.

167_{v2}
(PL-8)

KWIKSET

KEYING KITS, PINS, KEYING ACCESSORIES (Continued)

Kwikset

KW-20622

Steel learning tool for SmartKey® cylinders.



KW-83260 SmartKey® (SMT) Reset Cradle

The SmartKey Reset Cradle is a tool used to repair a SmartKey cylinder that has been programmed incorrectly. This can occur if the cylinder will not turn in either direction. Simple and easy to use. Simply remove the lock from the door, remove the SmartKey cylinder plug, insert into the reset cradle and the cradle will reset the cylinder to learn a new key. A must have for landlords or where there is a high possibility of lost keys.

See page 172 for "How to re-key a SmartKey cylinder".

CYLINDERS

REPLACEMENT CYLINDERS

For:	Stock No.
740 (Hancock) Entry Locksets	KW-13752
740 (Abbey) Entry Locksets	KW-7750A
740 (Circa) Entry Locksets	KW-13753
780 Single Cylinder Deadbolt	KW-87765
785 Double Cylinder Deadbolt (Interior)	KW-87767
785 Double Cylinder Deadbolt (Exterior)	KW-87766

Specify finish: **US-3 or 26D** (some also LO3, 5, 15A)

KNOB CYLINDER COVERS

For:	Stock No.
Abbey Design	KW-8501-11
Circa Design	KW-8501-15
Cortez, Roman, Hancock Design	KW-8501-01*
780 Single Cylinder Deadbolt	KW-81327
785 Double Cylinder Deadbolt	KW-81328

Specify finish: **US-3 , 5, 26D** (*also US-LO3)

KNOB CYLINDERS WITH OPTIONAL KEYWAYS

For:	Stock No.
Schlage Keyway	KW-8497-75
Master Keyway	KW-8497-77
Weslock Keyway	KW-8497-78
Weiser Keyway	KW-8497-76

Specify finish: **US-3 or 26D**

LEVERS & LAUREL KNOB CYLINDERS WITH OPTIONAL KEYWAYS (Special order)

For:	Stock No.
Schlage Keyway	KW-81355
Weiser Keyway	KW-81354

Specify finish: **US-3 or 26D**

DEADBOLT CYLINDERS WITH OPTIONAL KEYWAYS

For:	Stock No.
Schlage Keyway	KW-8486-75
Weiser Keyway	KW-8486-76
Master Keyway	KW-8486-77
Weslock Keyway	KW-8486-78

Specify finish: **US-3 or 26D**

REKEYING TOOLS

For:	Stock No.
Schlage Keyway	KW-8485-75
Weiser Keyway	KW-8485-76
Master Keyway	*KW-8485-77
Weslock Keyway	*KW-8485-78

*Being Discontinued

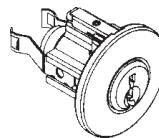

KW-1850 US-3, 5, 26D

Replacement cylinder for Kwikset 400 Series Knob Locks. (Not Eclipse or Polo)

KWIKSET

MISCELLANEOUS PARTS

Kwikset

SPINDLES

*Limited Availability
Discontinued by factory*

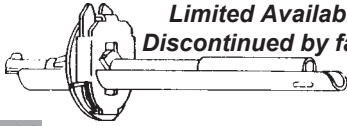

- KW-4738** 640 Series Spindle Assembly
KW-5334 401, 404, 411, 414, 451 Spindle Assembly
KW-5344 300 Spindle Assembly

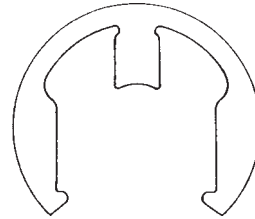

KW-84215
Deadlock Plug Retainer

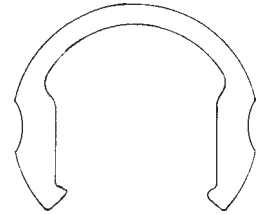

KW-84345
Knob Plug Retainer

SCREWS

Limited Availability - Discontinued by factory

- KW-2715** 665 One Way Interior Screw (Old Style)
KW-2761 660 Regular Interior Screw (Old Style)
KW-3224 885 One Way Oval Head Screw
KW-3225 885 Regular Interior Screw
KW-4424 880/885 Mounting Studs
KW-6070 660/870 Regular Interior Screw (New Style)
KW-6071 665/875 Regular Interior Screw (New Style)
KW-6118 665/875 One Way Oval Head Screw
Stock US-3 finish on above parts.

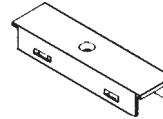

- KW-85757** 5 Pin
KW-83561 6 Pin
Tumbler Pin Cover

660/665 SCREW PACKS

- KW-86099** For 665 US-3
KW-86171 For 660 3, 11P, 26D

THICK DOOR KITS

- KW-81248** 980/982/980S/982S Deadbolts
KW-81249 985/984/985S/984S Deadbolts
KW-81691 780 Deadbolts
KW-84221 785 Deadbolts
KW-86129 660 Deadbolts US-3
KW-86130 665 Deadbolts US-3
KW-81714 Signature Knobs: A, CA, H, L
KW-81706 For: CN, C, LL, TNL, P, T, CHL, DL,
DNL, BL, ADL, AVL, BRL, PML in US-3

664 CONVERSION KIT

- KW-664** **US-5, 26D** For converting Kwikset 663 (one sided deadbolt) to a 667 (one sided w/exterior plate). Kit includes: Blank plate, screws and torque blade.

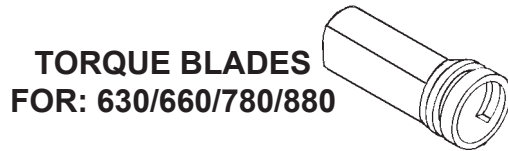

TORQUE BLADES FOR: 630/660/780/880

- KW-84991** Std. Door 630/660/780/880 Torque Blade—1-3/8" - 1-3/4"
KW-84992 Thick Door 630/660/780/880 Torque Blade—1-7/8" - 2-1/4"
KW-84987 Std. Door 635/665/785/885 Torque Blade Exterior—1-3/8" - 1-3/4"
KW-84993 Std. Door 635/665/780/885 Torque Blade Interior—1-3/8" - 1-3/4"
KW-84988 Thick Door 635/665/785/885 Torque Blade Exterior—1-7/8" - 2-1/4"
KW-84994 Thick Door 635/665/785/885 Torque Blade Interior—1-7/8" - 2-1/4"

DUMMY ADAPTORS

KW-81892

US-3, 15, 15A, 26D

For installing dummies on hollow core doors.

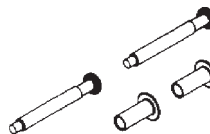

©ZIPF LOCK COMPANY

SUPER SPECIAL PRICING AVAILABLE ON ITEMS MARKED WITH ■ - SUPPLIES LIMITED - PLEASE INQUIRE.

169_{v2}
(PL-8)

KWIKSET

KWIKSET LATCHES

Kwikset
The Beauty of Strength™

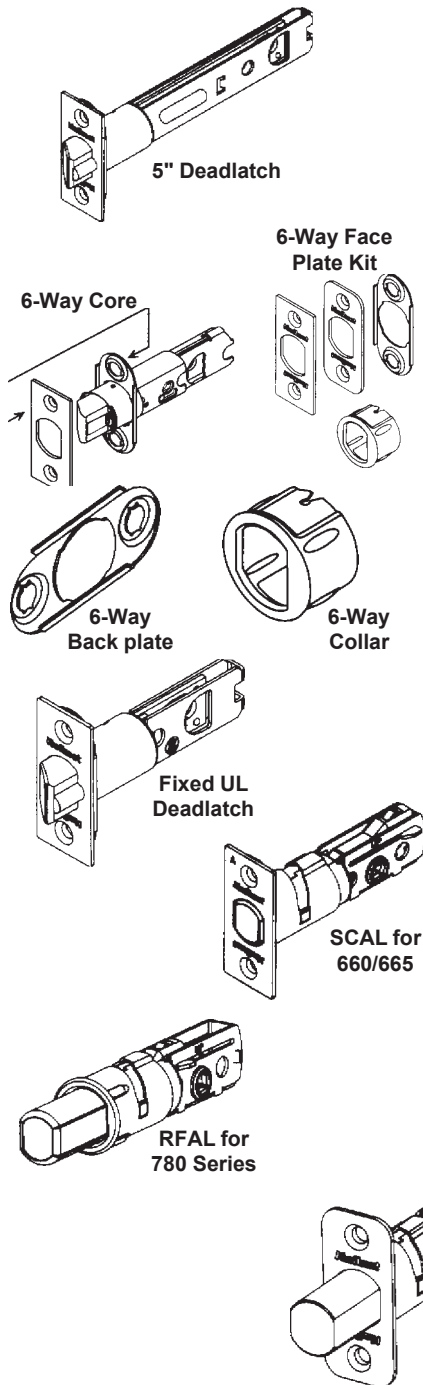

Description

Fixed Latches—

5" Deadlatch
5" Deadbolt (Kwikset Security)

Stock No.

ZL-159
ZL-631

Factory No.

83014
82730

6-Way Adjustable Latches—

6-Way Core Plain Latch
6-Way Plain Latch Collar
6-Way Plain Latch Service Kit

ZL-613
ZL-613C
ZL-613FP

81847
81829
81845

6-Way Core Deadlatch
6-Way Deadlatch Collar
6-Way Deadlatch Service Kit

ZL-616
ZL-616C
ZL-616FP

81846
81828
81844

6-Way Back Plate

ZL-613BP

81827

U.L. Listed Fixed Latches—

2-3/8" U.L. Latch

ZL-627

84296

660-665 Series Deadbolt Latches (600 Series Handlesets)—

SCAL - Adjustable Square Corner Latch
RCAL - Adjustable Round Corner Latch
RFAL - Adjustable Drive-in Latch

ZL-618
ZL-618RC
ZL-619

81308
81305
81306

780-785 Series Deadbolt Latches (500 Series Handlesets)—

SCAL - Adjustable Square Corner Latch
RCAL - Adjustable Round Corner Latch
RFAL - Adjustable Round Face Latch

ZL-497
ZL-497RC
ZL-498

86084
86085
84505

980-980S Series Deadbolt Latches (800 Series Handlesets)—

SCAL - Adjustable Square Corner Latch
RCAL - Adjustable Round Corner Latch
RFAL - Adjustable Round Face Latch

ZL-623
ZL-623RC
ZL-624

81254
81253
81255

Please specify finish when ordering latches.

KWIKSET

KEY BLANKS

Kwikset

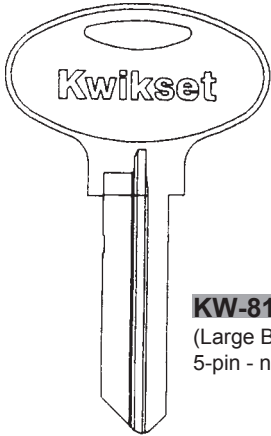

KW-81695
(Large Bow, Builders Key
5-pin - not pictured)

KW-83559
(Builders Key 6-pin)

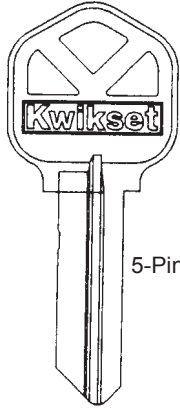

5-Pin

KW-81063
KW-81063-250PK
Nickel Plated



6-Pin

KW-87615
Rekeying tool for
6-pin knobs &
deadbolts

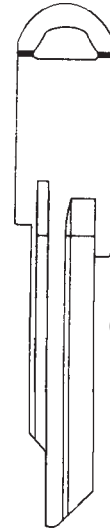

6-Pin

Key-in-Levers
standard "TC"

KW-81804

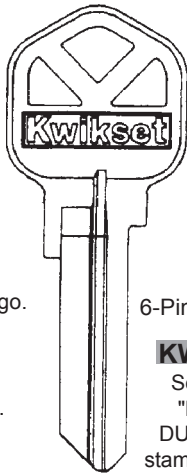

KW-81209
Solid Bow-
"KWIKSET
BLDR'S KEY"
stamped on key.
Nickel Plated, no logo.

6-Pin

KW-81210
Solid Bow-
6-pin, Nickel Plated.

KW-81693
Solid Bow-
"DO NOT
DUPLICATE"
stamped on key.

KW-81208
Nickel Silver

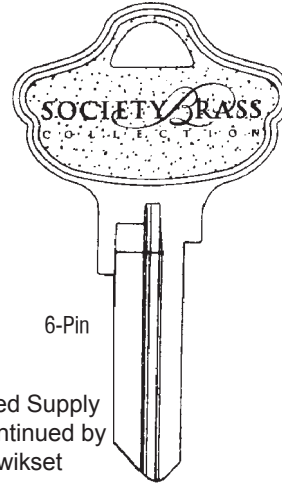

6-Pin

Limited Supply
Discontinued by
Kwikset

KW-80366
Nickel Silver

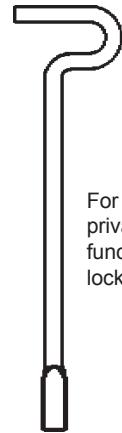

For all
privacy
functions
locksets

KW-81087
Emergency Key

POCKET DOOR LOCKS

Kwikset

The Beauty of Strength™

12 locks per case.

Round Pocket Door Lock

- Fits standard 2-1/8" prep.
- Installs in minutes.
- Auto Catch Lock Mechanism.
- Lifetime Mechanical Warranty.
- Lifetime Finish Warranty.

Stock No.	Description
KW-334	Passage
KW-335	Privacy

Specify Stock No. and Finish.

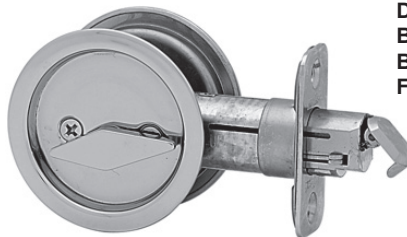

SPECIFICATIONS

DOOR THICK:	1-3/8" to 1-3/4"
BACKSET:	2-3/8"
BORE:	2-1/8" x 1"
FINISHES:	US-3 (605) Polished Brass US-5 (609) Antique Brass US-10B (613) Oil Rubbed Bronze US-15 (619) Satin Nickel US-15A (620) Antique Nickel US-26D (626) Satin Chrome US-32 (629) Bright Stainless Steel

SUPER SPECIAL PRICING AVAILABLE ON ITEMS MARKED WITH ■ - SUPPLIES LIMITED - PLEASE INQUIRE.

171_{v1}
(PL-8)

©ZIPF LOCK COMPANY

KWIKSET

INSTALLATION KIT

Kwikset

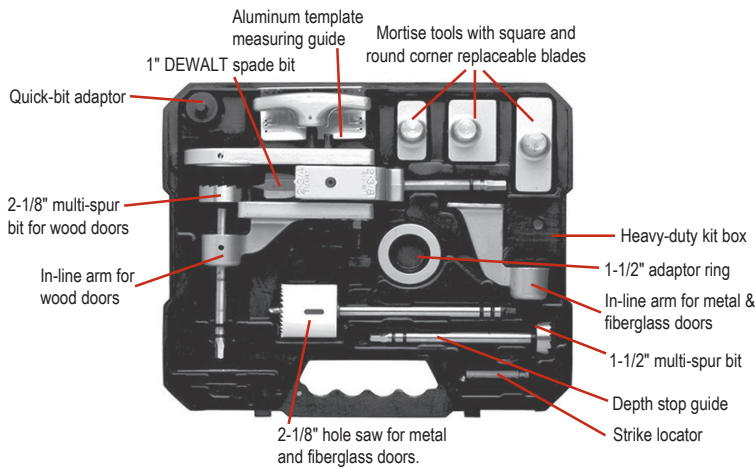

KW-138 Installation Kit

All-In-One Boring Jig-Unique design for drilling wood, fiberglass and metal* doors. Drills 2-1/8" and 1-1/2" standard door prep. For 2-3/8" and 2-3/4" backsets

**Wood edge boring only*

KW-89900

All-In-One Boring Jig
(used in KW-138)

Jig with wood arm guide. Unique design for drilling wood, fiberglass and metal* doors. Drills 2-1/8" and 1-1/2" standard door prep. Tool free backset adjustment.

**Wood edge boring only*

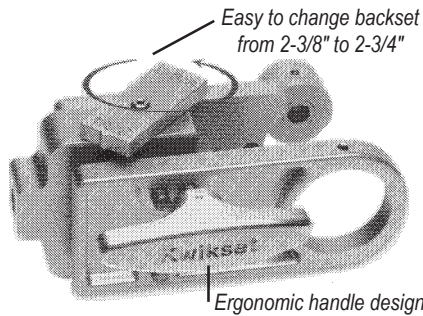

*Part No.	Description
KW-89900	Jig with wood arm guide. (See below)
KW-89901	In-line guide arm for wood doors.
KW-89902	In-line guide arm for metal doors.
KW-89903	1" DEWALT® spade bit.
KW-89904	2-1/8" multi-spur bit.
KW-89905	1-1/2" multi-spur bit.
KW-89906	2-1/8" metal hole saw bit.
KW-89907	Hole saw madrel.
KW-89908	Snap rings.
KW-89909	Full lip strike Mortise tool.
KW-89910	Full lip round corner strike blades.
KW-89911	Full lip square corner strike blades.
KW-89912	Latch mortise tool.
KW-89913	Latch round corner blades.
KW-89914	Latch square corner blades.
KW-89915	Maximum security strike mortise tool.
KW-89916	Maximum security round corner blades.
KW-89917	Maximum security square corner blades.
KW-89918	Quick bit changer.
KW-89919	Strike locator.
KW-89920	Strike locator tip.
KW-89921	Kit box.
KW-89922	Jig bushing.
KW-89923	1-1/2" adaptor ring.
KW-89924	663 Boring Depth stop guide.
KW-89925	Aluminum template measuring guide.

***Bold part numbers are stocked items. Balance special order.**

HOW TO RE-KEY A SMARTKEY® CYLINDER IN 3 SIMPLE STEPS.



EASILY RE-KEY IN 3 SIMPLE STEPS:

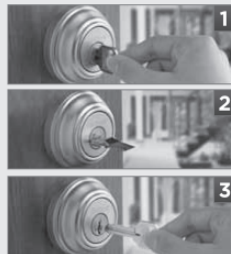

You must have your functioning key & your SmartKey tool for the system to work.

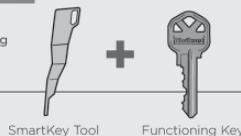

KW-83260

SmartKey® (SMT) Reset Cradle

The SmartKey Reset Cradle is a tool used to repair a SmartKey® cylinder that has been programmed incorrectly. See page 168 for more details.



KW-20622

Steel learning tool for SmartKey® cylinders.

KWIKSET

DOOR CLOSERS

DISCONTINUED BY FACTORY.
CALL FOR GREAT CLOSEOUT PRICES.

Kwikset AUTOMATIC DOOR CLOSERS

Durable, Efficient, Economical
For Residential Use
For Wood or Metal Interior Doors

No.	Description
KW-960C	Cocoa Color
KW-960E	Eggshell Color

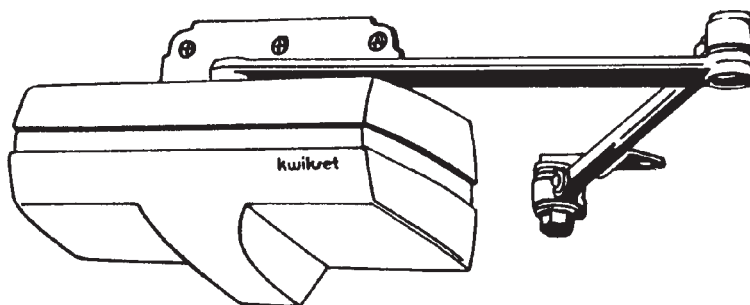

OIL SEAL is O-ring low friction unit.

SPINDLE is one piece, precision-machined from alloy steel for increased strength.

RACK AND PINION mechanism is machined of alloy steel to precise standards, assuring smoother operation and longer life.

SPRINGS are crafted from high-tensile, oil-tempered steel, which minimizes possibility of breakage or metal fatigue.

SPEED CONTROL VALVE is positioned for easy access. A slight turn with a standard screwdriver adjusts the unit to desired closing speed.

OVERALL SIZE is 5-3/4" long, 2-5/8" deep, 1-7/8" high.

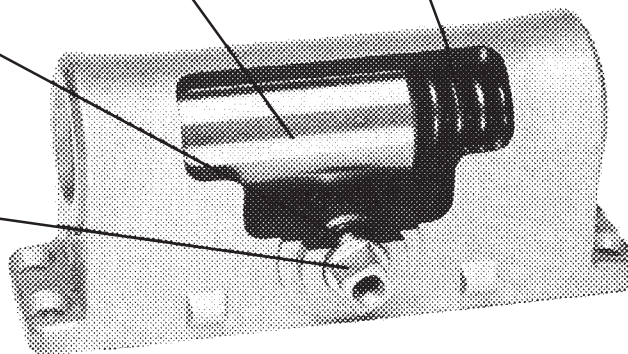

FEATURES:

- Easy do-it-yourself installation.
- Adaptable to right or left-handed door swing.
- Special mounting brackets.
- Built-in hold-open functions.
- Closing speed control.
- Conserves energy dollars.

Kwikset's new automatic door closer is the ideal helpmate for any interior household door. Specially designed for internal doors, bathroom, bedroom, patio, laundry or garage, wherever automatic closing is desired. Its built-in hold-open function eliminates problems getting parcels, laundry, groceries and other bulky items through doorways. And the adjustable speed valve can speed up or slow down the door as

needed. Kwikset's automatic door closer even helps conserve energy and save dollars by keeping in cool air in summer—warm air in winter.

INSTALLATION EASY, DO-IT-YOURSELF

Its compact size and design allows it to fit neatly on any interior wood or aluminum door. It can be installed in minutes with household tools. Each package contains 2 special mounting plates (brackets). One will conform to the customer's door top jamb configuration. Installation is PARALLEL and is adaptable to RIGHT or LEFT-hand door swing.

SPECIFICATIONS:

Applicable Door: Wood or Aluminum
Maximum Door Size: 36" W x 80" H.
Maximum Door Weight: 60lbs
Size: 5-3/4" long, 2-5/8" deep, 1-7/8" high
Rack and Pinion: One piece alloy steel
Spindle: One piece alloy steel
Springs: High-tensile oil tempered steel
Oil Seal: Low-friction O-ring unit

KWIKSET

DOOR CLOSERS

- U.L. Listed

Kwikset

TYLO DOOR CLOSER

**DISCONTINUED BY FACTORY.
CALL FOR GREAT CLOSEOUT PRICES.**



The Tylo door closer by Kwikset combines virtually all features found only in expensive door closers and offers them at an economical price. They are available in a variety of sizes to suit different door sizes and use requirements

SPECIFICATIONS

- **Degree of Opening:** Maximum degree of opening for all closers is 180 degrees.
- **Door Weight:** When ordering closers according to door size limitation as shown below, the actual maximum size of the door recommended is largely determined by existing draft conditions and by door weight, e.g., if door is a size calling for a 962 closer and subject to strong drafts, a 963 should be used.
- **Case:** High strength pressure cast aluminum.
- **Adjustable Arms:** One length for all applications. Minimum top jamb 1-3/4". Forged steel, malleable iron and wrought parts.
- **Rack and Pinion:** One-piece alloy steel.
- **Spindle:** One-piece high-tensile, heat-treated alloy steel.
- **Springs:** High-tensile, heat-treated steel.
- **Oil-Seal:** Low-friction O-ring unit.
- **Valves:** Needle-type non-critical with O-ring seals.
- **Checking Fluid:** High-lubricity, low-pour-point; same fluid used on all Tylo closers.

Finishes: **US-10** Satin Bronze Enamel
US-28 Satin Aluminum Enamel
US-035 Duranodic

FEATURES

- **Speed Valve** is needle type, assuring precise control of closing speed.
- **Adjustable:** Closing speed is easily regulated to permit adjustment of closer to different conditions and requirements.
- **Invertible:** Tylo door closer may be installed conventionally or mounted inverted.
- **Flexibility:** Not handed and operate with equal efficiency.

NUMBER	Recommended closer size for doors 7' high			Maximum Door Weight (lbs)
	Maximum size of door			
Regular	Interior	Exterior inswing	Exterior outswing	
KW-962	3'0"	—	—	55-100
KW-963	3'6"	2'6"	3'0"	88-143

POWER ADJUSTMENT ARM BRACKET

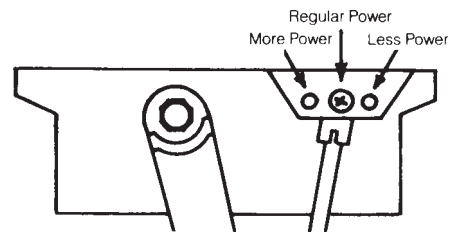

Regularly furnished with all non hold-open closers. May be mounted to supply regular closing power or adjusted to supply a minimum of 15% greater closing power.

PARALLEL ARM ADAPTERS

KW-946 For regular arm US-035, 10, 28
KW-947 For Hold-open arm US-10, 28

HOLLOW-CORE DOORS (SEX BOLTS)

KW-1192 28 1-3/4" door US-28
KW-1194 28 1-3/8" door US-28
 •Set of 4 sex bolts for metal doors.
CR-970 1-3/8 1-3/8" door US-26D
CR-970 1-3/4 1-3/4" door US-10, 26D
 •Set of 4 sex bolts for metal doors.

©ZIPF LOCK COMPANY