

Job Name: _____
Location: _____
Contact #: _____



Specifications

Model

400680—Brushed nickel finish
818019—Chrome finish

18" Towel Bar

Description

- o Easy installation
- o Lifetime warranty
- o Metal construction
- o Matching faucet of 400680 is 412379

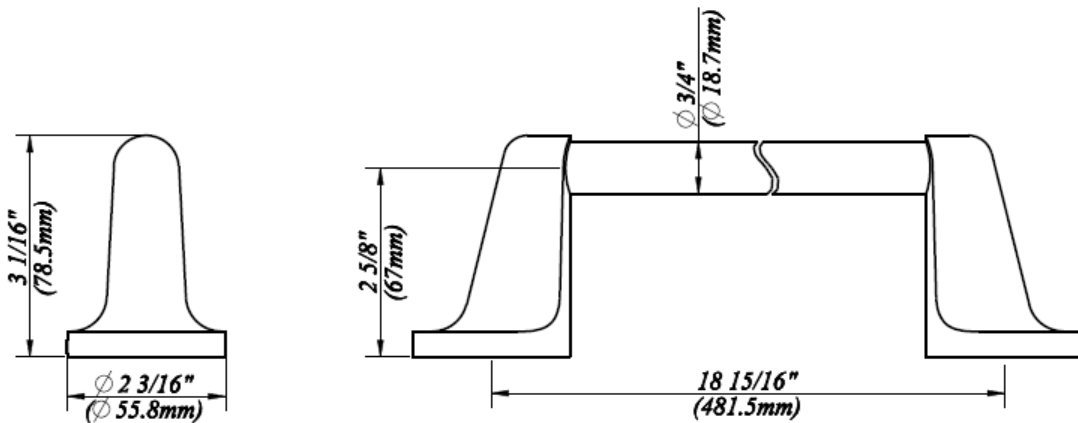

Technical Support

888-328-2383

Manufacturer model# B7001101

Warranty Parts List

18" Towel Bar

#	Description	Part #
1	holding hardware	A290552
2	screw ((M5 *10 mm L)	A292401NI
3	18" towel bar	A250212

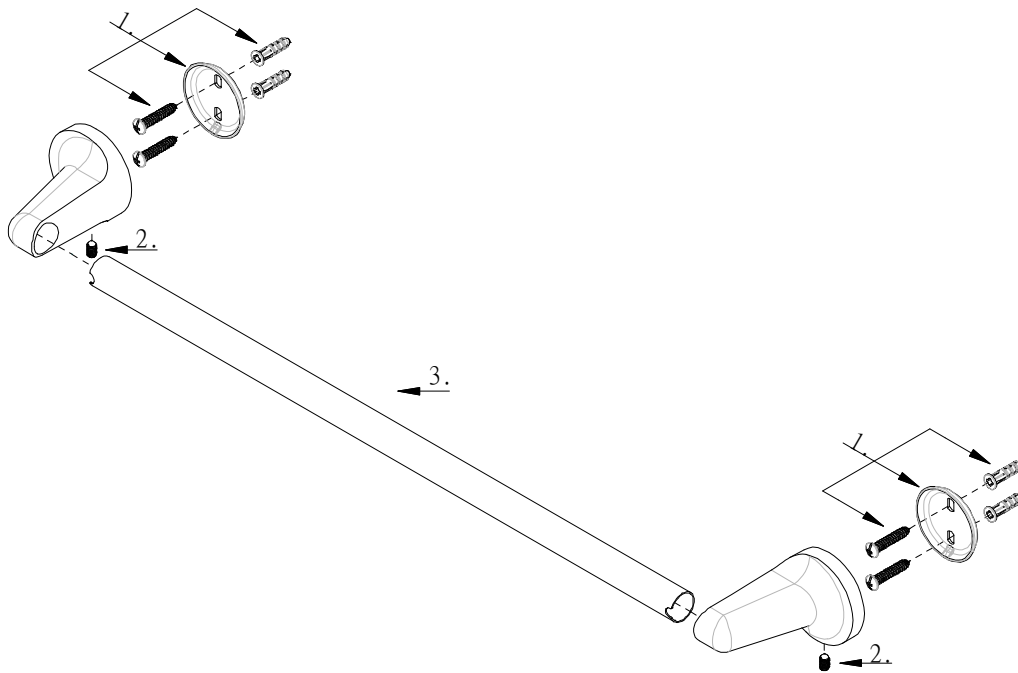

Technical Support

888-328-2383

Manufacturer model# B7001101