

4C Recessed Mounted Horizontal Mailboxes – 3700 Series

FRONT LOADING Installation Instructions

IMPORTANT!

After installing the unit, contact your local postmaster – the USPS will provide and install its own master lock on your mailbox unit. Hardware and instructions for installing the master lock are included inside the unit. Please provide the hardware and instructions to the USPS representative when they arrive to install the lock.

U.S.P.S. APPROVED

With its quality design and construction, Salsbury Industries' 3700 series USPS approved 4C recessed mounted horizontal mailboxes will provide years of maintenance free service. These units meet all the requirements of USPS STD-4C, the new high-security standard developed by the United States Postal Service.

4C recessed mounted horizontal mailboxes can be installed either with the included connector kits (see instructions on pages 2-5) or separately with individual wall framing (see page 6).

TYPICAL INSTALLATION

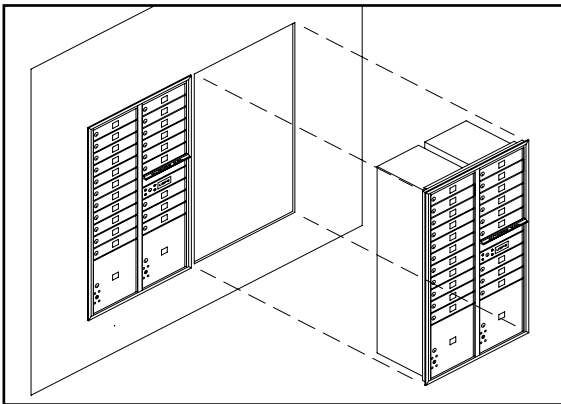

PREPARATORY STEPS

1. Have mailboxes and instructions on hand before starting wall construction.
2. Unpack and review contents of shipping cartons.
3. Gather tenant and parcel locker keys and store in a secure place.
4. Read installation instructions document thoroughly.
5. Determine rough opening size(s).
6. Determine rough opening location above finished floor.
7. Determine framing configuration and location.
8. Procure materials for wall construction.

NOTES

1. Although these mailboxes have been tested and approved for both outdoor and indoor use, some shelter from direct weather conditions should be provided, especially in areas with heavy rainfall. This provides protection for the mail, the delivery personnel, and the mail patrons.
2. The mailboxes are shipped fully assembled.
3. Hardware is included to fasten each unit into a wood framed wall.
4. Trim is an integral part of the mailbox assembly. There is no other snap on trim to install.

USPS REGULATIONS

The mailboxes must be installed according to Postal Regulations.

1. The floor of the lowest patron mailbox shall be no less than 28" above the finished floor (AFF).
2. The patron lock in the highest mailbox shall be no more than 67" above the finished floor.
3. The USPS Arrow lock (master door lock) opening must be a minimum of 36" and a maximum of 48" above the finished floor.
4. The floor of the lowest parcel locker shall be no less than 15" above the finished floor.
5. The master access door(s) must be allowed to open a minimum of 90 degrees with no obstruction.
6. There must be at least one parcel locker for every ten patron mailboxes in installations of 10 or more patron mailboxes. Parcel lockers must be a minimum of 15" high (PL4.5, PL5 and PL6) to meet the 1:10 ratio. Once this ratio has been met, smaller parcel lockers (PL3 and PL4) may also be added. There is no requirement for parcel lockers in installations of less than 10 patron mailboxes, but one or more parcel lockers is recommended.

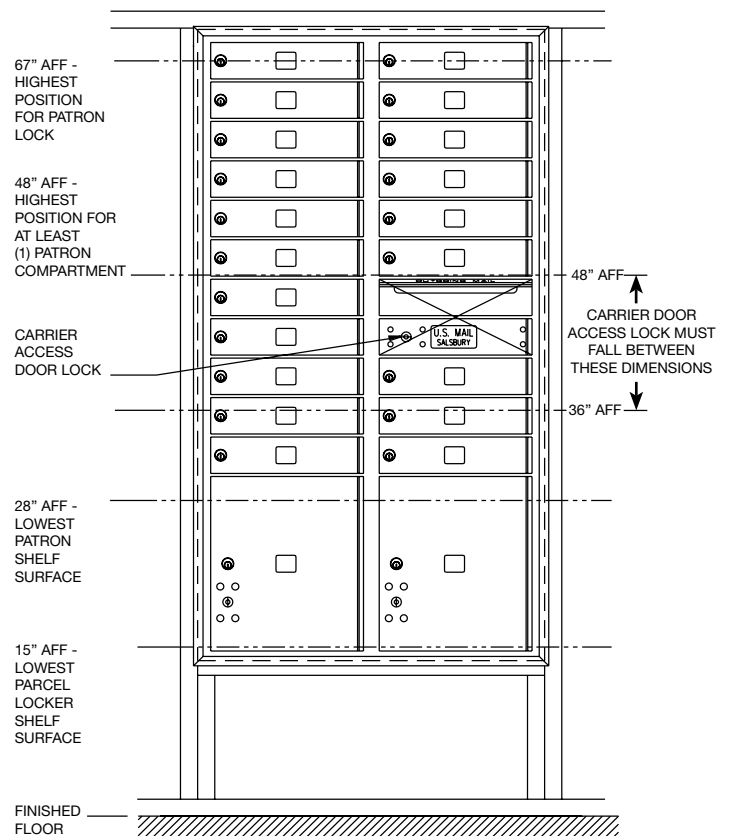

SALSBURY INDUSTRIES

1010 East 62nd Street, Los Angeles, CA 90001-1598

Phone: 800-624-5269

Int'l Phone: 323-846-6700

Fax: 800-624-5299

Int'l Fax: 323-846-6800

www.mailboxes.com

engineering@mailboxes.com

4C Recessed Mounted Horizontal Mailboxes – Connector Kit Front Loading Unit Installation Instructions

Rough Opening

Height: See chart on page 6.

Width: To establish the size of the rough opening(s) in the wall(s) you will be installing your mailbox configuration(s) into, calculate the overall width of the total amount of units per wall installation; then subtract 3/4" from the width grand total.

Example: (2) double-column mailboxes are to be installed.

- Each unit is 31-1/8" wide x 2 units = 62-1/4"
- 62-1/4" - 3/4" = 61-1/2" required for rough opening.

Hardware required for installation

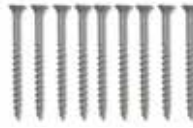

-#8 square drive x 2" long wood screws (provided with mailbox)



-Connector #8 x 1/2" pan head self tapping machine screws (provided with each 4C Connector Kit)

STEP 1

Place the first unit into the rough opening (see figure 1). Open the master door(s) to locate the 2x4 mounting holes on the inside corner of the mailbox's trim panel (see figure 2 for the difference between the 2x4 mounting holes and the connector kit mounting holes). Attach unit to the 2x4 wood framing (using the provided #8 square drive x 2" long wood screws) on the side, top and bottom sections of the mailbox unit (see figures 3 through 6 on the next page).

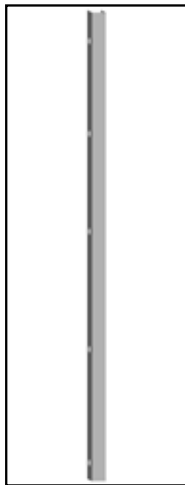

Connector bar corresponds to unit height

Figure 1



Figure 2



2 x 4 mounting hole

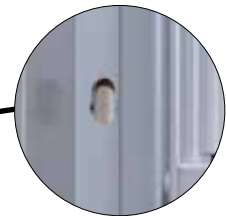

Connector kit mounting hole

SALSBURY INDUSTRIES

1010 East 62nd Street, Los Angeles, CA 90001-1598

Phone: 800-624-5269

Int'l Phone: 323-846-6700

Fax: 800-624-5299

Int'l Fax: 323-846-6800

www.mailboxes.com

engineering@mailboxes.com

Figure 3 – Top side of unit facing wall



Figure 4 – Bottom side of unit facing wall



Figure 5 – Top of unit



Figure 6 – Bottom of unit



Overtightening beyond initial contact with frame could hinder functionality. If overtightening occurs, simply back out each overtightened mounting screw.

STEP 2

Locate the connector kit mounting holes on the opposite connecting side of the mailbox unit (see Step 1-Figure 2 for hole identification). Align the holes on the 4C connector bar with the holes located on the mailbox unit (see figures 7-9). Attach connector bar to the mailbox unit with the provided #8 x 1/2" pan head self tapping machine screws (see figures 10-11). The installation should now look like figure 12 - next page.

Figure 7



Figure 8



Figure 9



SALSBURY INDUSTRIES

1010 East 62nd Street, Los Angeles, CA 90001-1598

Phone: 800-624-5269

Int'l Phone: 323-846-6700

Fax: 800-624-5299

Int'l Fax: 323-846-6800

www.mailboxes.com

engineering@mailboxes.com

Figure 10 – Top side of unit facing 4C Connector Bar



Figure 11 – Bottom side of unit facing 4C Connector Bar



Figure 12 – 4C Connector Bar is now attached to mailbox unit



STEP 3

With assistance, align the second unit up to the first unit, butting the trim of both units up to one another (see figures 13-15). Attach the second unit to the connector bar (using the remaining #8 x 1/2" pan head self tapping machine screws) via the mounting holes located on the inside trim of the second unit (see figure 16).

Using #8 square drive x 2" long wood screws, secure the top and bottom of the unit to the wall (see figures 5 and 6 on page 3).

Figure 13



SALSBURY INDUSTRIES

1010 East 62nd Street, Los Angeles, CA 90001-1598

Phone: 800-624-5269

Int'l Phone: 323-846-6700

Fax: 800-624-5299

Int'l Fax: 323-846-6800

www.mailboxes.com

engineering@mailboxes.com

Figure 14 – Align units up next to each other.



Figure 15 – Butt each unit's trim up against the other.



Figure 16– Secure units together using connector machine screws



STEP 4

If necessary, repeat this process for additional units to be installed.

STEP 5

Attach the last mailbox unit used in your installation to the wall framing on the opposite side of the rough opening using #8 square drive x 2" long wood screws.

This completes installation of your mailboxes using the 4C Connector Kit(s).



SALSBURY INDUSTRIES

1010 East 62nd Street, Los Angeles, CA 90001-1598

Phone: 800-624-5269

Int'l Phone: 323-846-6700

Fax: 800-624-5299

Int'l Fax: 323-846-6800

www.mailboxes.com

engineering@mailboxes.com

4C Recessed Mounted Horizontal Mailboxes – Wall Framing Installation Instructions

ROUGH OPENING DIMENSIONS

Each unit requires a separate opening in the drywall. Each pair of units will have a 2x4 stud separating them. The trim frames cannot be butted together. There will be a space between edges of trim frames of approximately 3/4" when 2x4 studs with drywall separate the mailboxes.

CALCULATION OF SPACE REQUIRED FOR MULTIPLE MAILBOXES

For overall width of mailbox installation, add up all of the stud spacings and subtract 3/4". For overall height of units, see the dimension chart below.

WALL CONSTRUCTION

Particular attention must be paid to wall framing to provide a strong and secure attachment of the mailbox units. Stud spacing must be accurate to ensure that there is minimum space between the studs and the mailbox frame and minimum mailbox frame distortion when the fasteners are tightened between the frame and the studs. Studs must be installed plumb and square to further ensure proper fit and function of the mailboxes.

INSTALLATION INSTRUCTION

1. Construct wall and mailbox support structure with drywall, 2x4 lumber, and 3/8" plywood. 2x6 lumber may be used for a stronger wall.
2. Cut a hole(s) in the wall according to the rough opening dimensions. Each mailbox unit assembly should have its own opening in the drywall.
3. Place unit(s) into rough opening(s). Open the carrier access door and open the front doors by lifting the latch handle on the left behind the carrier access door. See illustration on page 1 for location of carrier access door. Note the mounting hole locations and drill pilot holes into the studs. Securely fasten to the support framing with the screws provided. See illustration below. Install screws into all holes provided in both right and left side vertical trim frame members.
4. Caution: Do not deform, force or twist the frame to fit an incorrect rough opening or against an irregular surface. Do not overtighten the installation screws. If necessary, shim the small space between the stud and the vertical, extruded aluminum trim frame. Test all master doors, patron doors, and parcel locker doors to ensure that they open and swing freely without binding or sticking.

FASTENING MAILBOX UNIT TO FRAMING

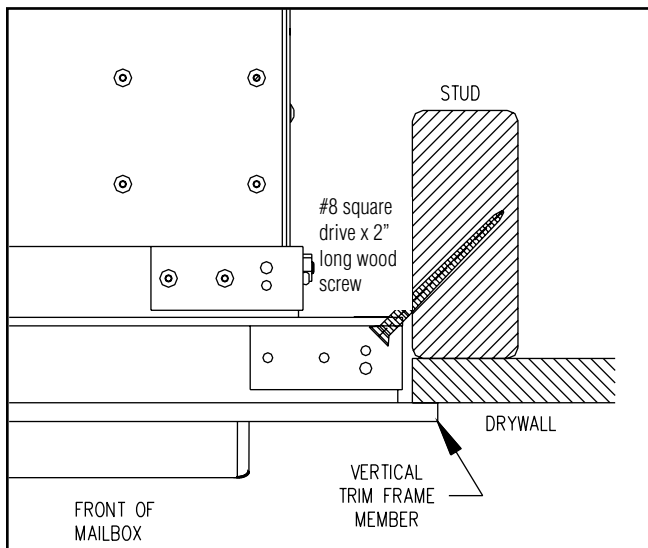

DIMENSIONS – FRONT LOADING

WIDTHS	SINGLE COLUMN	DOUBLE COLUMN
Overall	16-3/8"	31-1/8"
Rough Opening	15-5/8"	30-3/8"
Stud Spacing	17-1/8"	31-7/8"

HEIGHTS	OVERALL	ROUGH OPENING
Maximum Height	56-3/4"	56"
15 Doors High	55"	54-1/4"
14 Doors High	51-1/2"	50-3/4"
13 Doors High	48"	47-1/4"
12 Doors High	44-1/2"	43-3/4"
11 Doors High	41"	40-1/4"
10 Doors High	37-1/2"	36-3/4"
9 Doors High	34"	33-1/4"
8 Doors High	30-1/2"	29-3/4"
7 Doors High	27"	26-1/4"
6 Doors High	23-1/2"	22-3/4"
5 Doors High	20"	19-1/4"
4 Doors High	16-1/2"	15-3/4"
3 Doors High	13"	12-1/4"

WALL FRAMING RECOMMENDATION

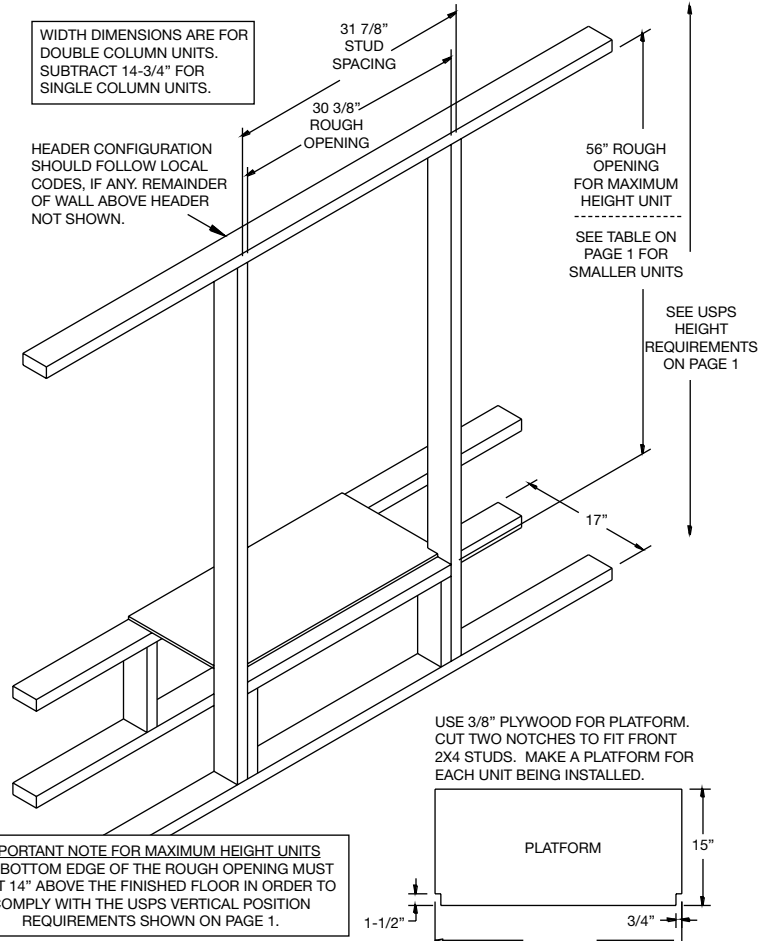

SALSURY INDUSTRIES		31-7/8"
1010 East 62nd Street, Los Angeles, CA 90001-1598		
Phone: 800-624-5269	Int'l Phone: 323-846-6700	Fax: 800-624-5299
www.mailboxes.com		Int'l Fax: 323-846-6800
engineering@mailboxes.com		