

INSTALLATION AND SAFETY INSTRUCTIONS

IMPORTANT SAFETY INSTRUCTIONS

- Be sure the electricity to the system you are working on is turned off; either the fuse removed or the circuit breaker set at off.
- Use of other manufacturers components will void warranty, listing and create a potential safety hazard.
- If you are unclear as to how to proceed, contact a qualified electrician.
- You don't need special tools to install this fixture.
- Be sure to follow the steps in the order given.
- Read instructions carefully.
- Save these instructions.

BEFORE YOU BEGIN

Carefully remove the fixture from the carton and check that all parts are included, as shown in Figures 1 & 2. Be careful not to misplace any of the screws or parts which are needed to install this fixture.

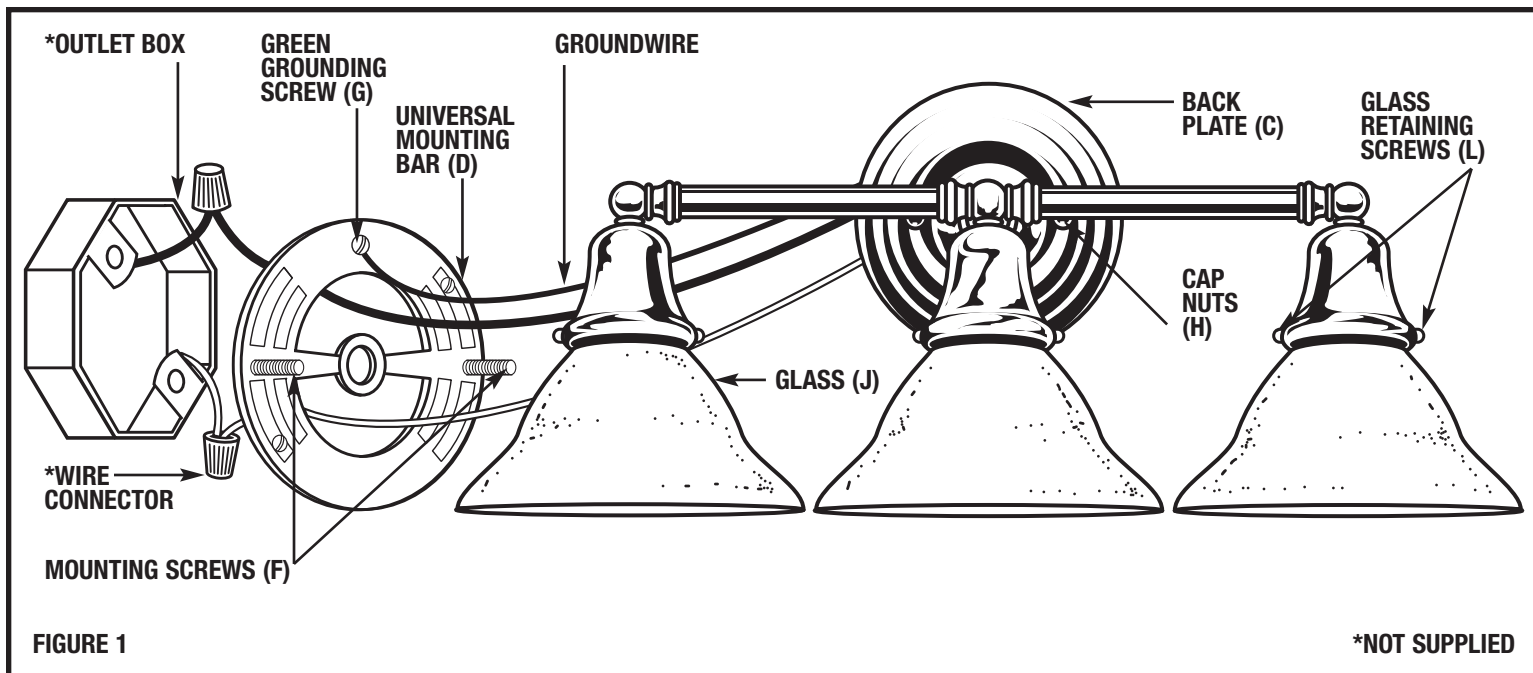

GROUNDING & UNIVERSAL MOUNTING BAR LOCK UP

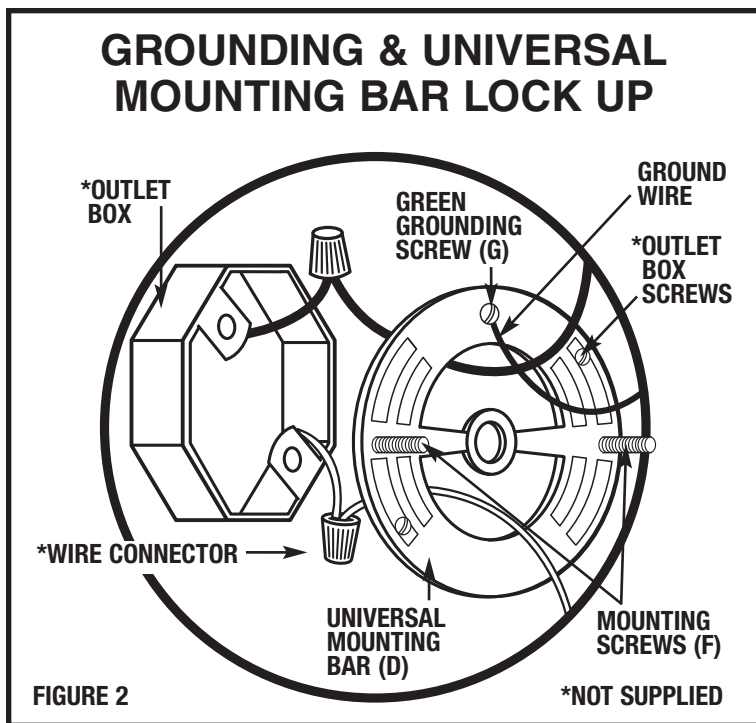

sea gull lighting®

Installation And Safety Instruction

HC-1330

012808

Line art shown may not exactly match the fixture enclosed. However, the installation instructions do apply to this fixture.

Fill In Item Number On Carton And
File This Sheet For Fixture Reference. ITEM# _____

IMPORTANT: DO NOT ATTACH FIXTURE DIRECTLY TO OUTLET BOX.

STEP 1:

Thread mounting screws (F) into holes of universal mounting bar (D) and run mounting screws (F) all the way down to their heads.

STEP 2:

Using outlet box screws (not supplied) fasten universal mounting bar (D) to outlet box through slots in universal mounting bar (D). Make sure mounting screws (F) are perfectly horizontal so fixture hangs properly.

STEP 3:

A. Take note of the color of the wire(s) on your fixture. Identify which group your fixture wire(s) falls into and connect the wires according to the directions below:

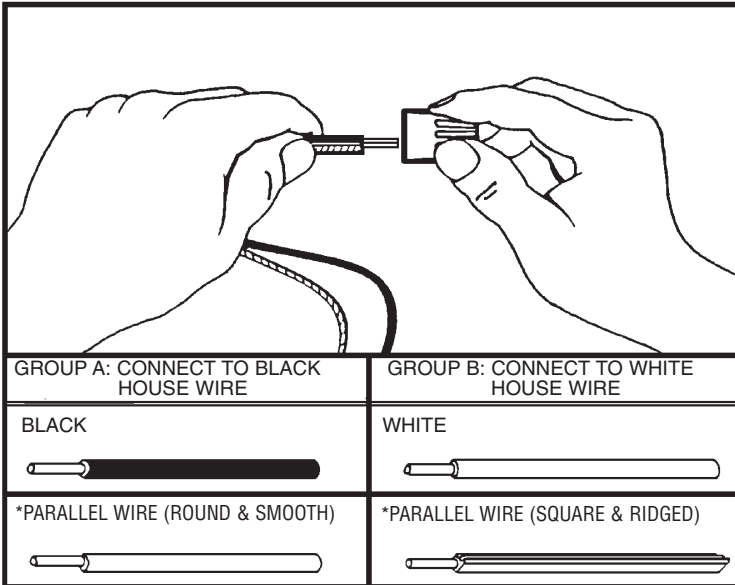

*Note: When parallel wire is used, the tracer wire is square shaped or ridged and less tracer wire is round in shape or smooth. (Seen best when viewed from wire end.) To separate wires, grasp the ends of each wire and pull apart.

- B. Take your fixture wire(s) from group A and place evenly against the black wire from the outlet box. **DO NOT** twist wires together before using wire connectors.
- C. Fit a wire connector (not supplied) over the wires and thread the connector clockwise until you feel a firm resistance.
- D. Gently try to remove the wires from the connector. If you can remove the wires, carefully re-do steps B and C, as above and check again for a firm connection.
- E. Connect the fixture wire from group B to the white wire from the outlet box in the same manner.

STEP 4:

GROUNDING INSTRUCTIONS: The green grounding screw (G) is to be inserted into the hole with two raised dimples provided on the universal mounting bar (D). Wrap the ground wire from the fixture (if supplied) and the ground wire from the outlet box (bare metal or green insulated wire) around the green grounding screw (G) on the universal mounting bar (D) if uninsulated wire is on the universal mounting bar (D), connect the ground wire from the fixture (if supplied) and the outlet box to it using a small wire connector (not supplied).

NEVER CONNECT GROUND WIRE TO BLACK OR WHITE POWER SUPPLY WIRES.

FINAL ASSEMBLY

STEP 1:

Make sure no bare wires can be seen outside wire connectors.

STEP 2:

After wires are connected, tuck them carefully inside outlet box. Push the backplate (C) firmly over the mounting screws (F) and against the wall. Secure backplate (C) in place by threading cap nuts (H) onto mounting screws (F).

STEP 3:

Place glass (J) around socket and secure in place by tightening glass retaining screws (L). Finger tighten only. Do not over tighten.

STEP 4:

Install lamps.

CLEANING

To clean, wipe fixture body with a soft cloth. Clean glass with a mild soap. Do not use abrasive materials such as scouring pads or powders, steel wool, or abrasive paper.

ORDERING PARTS

Keep this sheet for future reference, and in case you need to order replacement parts. Parts for this fixture can be ordered from place of purchase. Be sure to use exact wording from illustration when ordering parts.