



**LEDVANCE**

Licensee of product  
trademark SYLVANIA  
in general lighting



Light is straightforward  
SYLVANIA LED Luminaires



---

## Table of Contents

SYLVANIA LED Luminaires Overview	3
Edge-Lit Panel	4-5
Volumetric Troffer	6-7
Retrofit Door Kit	8-9
Troffer Retrofit Kit	10-11
Surface Mount Series	12-14
Undercabinet Light and PenduLum™	15
High Bay	16-17
Linear High Bay	18-19
Vapor Tight	20-21
Garage	22-23
Canopy	24-25
Slim Floodlight	26-27
Slim Wall Pack	28-29
Wall Pack Cutoff	30-31
Wall Pack Non-Cutoff	32-33
Portfolio Overview	34-37
Accessories and Replacement Parts	38

# SYLVANIA LED Luminaires



Straightforward, efficient and easy-to-install products with proven quality and performance, perfectly matched to your everyday requirements. Advancing light together; we have developed the SYLVANIA LED luminaires to fit your needs.

## What are the benefits of SYLVANIA LED luminaires for you as a lighting professional?

SYLVANIA LED luminaires and retrofit kits are the ideal solution to fit your needs for everyday applications. The luminaires have all the necessary features and functions for the application they have been developed for — no more and no less.

## The portfolio has been designed to redefine the standard: we have taken the time to understand your needs and requirements as lighting professionals.

Not only do SYLVANIA LED luminaires provide a copious amount of energy savings, the portfolio provides the right design per application as well as easy installation with proven quality and performance. We have developed a comprehensive portfolio that matches a wide variety of needs for your day-to-day applications. Or in short: SYLVANIA — a brand you can trust.

All SYLVANIA LED luminaires comply with all the applicable standards and have all the relevant certificates and approvals, such as UL/ETL, RoHS, and FCC. In addition we always aim to meet energy efficiency standards set by Design Lights Consortium (DLC) and ENERGY STAR.

### The SYLVANIA LED luminaire portfolio includes:

- Edge-Lit Panel
- Volumetric Troffer
- Retrofit Door Kit
- Troffer Retrofit Kit
- Surface Mount Series
- Undercabinet Light and PenduLum™
- Traditional and Linear High Bay
- Vapor Tight
- Canopy
- Garage
- Slim Floodlight
- Wall Pack Series



# Edge-Lit Panel



Ideal replacement for traditional fluorescent luminaires.

SYLVANIA Edge-Lit Panels are energy saving, environmentally preferable LED alternatives to traditional fluorescent luminaires. Offered in three sizes with 3500K and 4000K color temperature options and luminous efficacy up to 110 LPW, all sizes are 0-10V dimmable down to 10% with optional emergency back-up. The slim design is ideal for installation in tight ceilings. They are constructed with an extruded aluminum frame, sheet metal back plate and PMMA diffused flat lens and come with a 5-year warranty.

### Recommended applications

- Offices, conference rooms and classrooms
- Reception areas and foyers
- Corridors and elevators

### Product overview

- Thin and seamless housing fits in standard 9/16" and 15/16" T-grid ceilings (Earthquake clips preinstalled on luminaire)
- Fast and easy installation
- Low glare, uniform light
- Energy savings of up to 47%
- Controls ready with 0-10V dimming for additional energy savings
- Rated life  $\geq 50,000$  hours ( $L_{70}$ )
- IC rated for dry locations
- Wide operating temperature range  $-4^{\circ}\text{F}$  to  $+104^{\circ}\text{F}$   
EM:  $+32^{\circ}\text{F}$  to  $+104^{\circ}\text{F}$



\* DLC applicable on standard versions

### Savings in energy and costs over the LED lifetime per fixture\*\* LED vs. Traditional

	Energy consumption	Costs
Fluorescent 2x4 3x32T8 ISL equivalent - 75W	3,750 kWh	\$508
SYLVANIA LED 2x4 Edge-Lit - 40W	2,000 kWh	\$220
<b>SAVINGS</b>	<b>47%</b>	<b>\$288</b>

\*\*Energy costs based on \$0.11/kWh.

Traditional costs include energy cost, cost to replace lamps and ballast over the LED product life. LED cost does not include cost of the luminaire.

### 1x4 Edge-Lit Panel

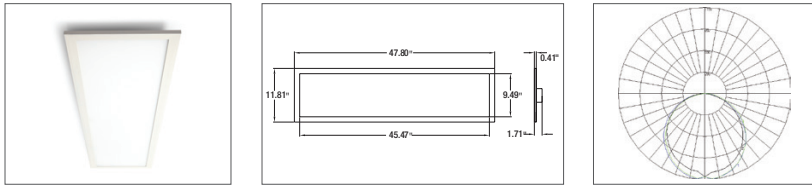

#### Ordering Information

Item Number	Product Description	Power (W)	Input Voltage	Dimming	Replacement for up to	Total Fixture Lumens	LPW*	Rated Life L <sub>70</sub> (hours)	CCT	CRI
74243	1x4 Edge-Lit Panel 32W 3500K	32W	120-277	0-10V	2x28W T8/2x32W T8	3200	102	≥50,000	3500K	>80
74245	1x4 Edge-Lit Panel 32W 3500K Emergency	32W	120-277	0-10V	2x28W T8/2x32W T8	3200	102	≥50,000	3500K	>80
74244	1x4 Edge-Lit Panel 32W 4000K	32W	120-277	0-10V	2x28W T8/2x32W T8	3300	104	≥50,000	4000K	>80
74246	1x4 Edge-Lit Panel 32W 4000K Emergency	32W	120-277	0-10V	2x28W T8/2x32W T8	3300	104	≥50,000	4000K	>80

\*LPW per LM79 Report

### 2x2 Edge-Lit Panel

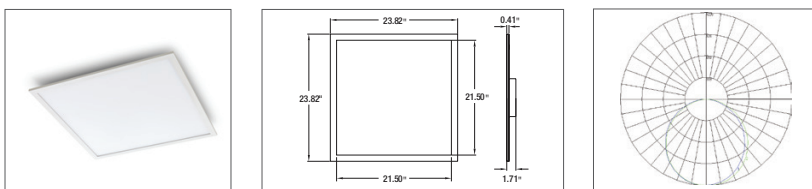

#### Ordering Information

Item Number	Product Description	Power (W)	Input Voltage	Dimming	Replacement for up to	Total Fixture Lumens	LPW*	Rated Life L <sub>70</sub> (hours)	CCT	CRI
74251	2x2 Edge-Lit Panel 32W 3500K	32W	120-277	0-10V	3x17W T8/2U31 T8	3500	110	≥50,000	3500K	>80
74253	2x2 Edge-Lit Panel 32W 3500K Emergency	32W	120-277	0-10V	3x17W T8/2U31 T8	3500	110	≥50,000	3500K	>80
74252	2x2 Edge-Lit Panel 32W 4000K	32W	120-277	0-10V	3x17W T8/2U31 T8	3500	110	≥50,000	4000K	>80
74254	2x2 Edge-Lit Panel 32W 4000K Emergency	32W	120-277	0-10V	3x17W T8/2U31 T8	3500	110	≥50,000	4000K	>80

\*LPW per LM79 Report

### 2x4 Edge-Lit Panel

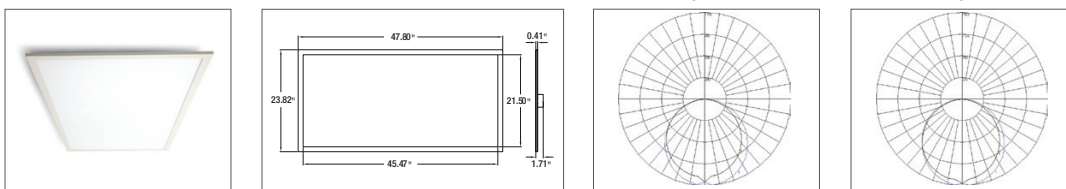

#### Ordering Information

Item Number	Product Description	Power (W)	Input Voltage	Dimming	Replacement for up to	Total Fixture Lumens	LPW*	Rated Life L <sub>70</sub> (hours)	CCT	CRI
74247	2x4 Edge-Lit Panel 32W 3500K	32W	120-277	0-10V	2x28W T8/2x32W T8	3300	104	≥50,000	3500K	>80
74239	2x4 Edge-Lit Panel 32W 3500K, Emergency	32W	120-277	0-10V	2x28W T8/2x32W T8	3300	104	≥50,000	3500K	>80
74248	2x4 Edge-Lit Panel 32W 4000K	32W	120-277	0-10V	2x28W T8/2x32W T8	3300	104	≥50,000	4000K	>80
74240	2x4 Edge-Lit Panel 32W 4000K Emergency	32W	120-277	0-10V	2x28W T8/2x32W T8	3300	104	≥50,000	4000K	>80
74249	2x4 Edge-Lit Panel 40W 3500K	40W	120-277	0-10V	3x28W T8/3x32W T8	4200	109	≥50,000	3500K	>80
74241	2x4 Edge-Lit Panel 40W 3500K Emergency	40W	120-277	0-10V	3x28W T8/3x32W T8	4200	109	≥50,000	3500K	>80
74250	2x4 Edge-Lit Panel 40W 4000K	40W	120-277	0-10V	3x28W T8/3x32W T8	4200	110	≥50,000	4000K	>80
74242	2x4 Edge-Lit Panel 40W 4000K Emergency	40W	120-277	0-10V	3x28W T8/3x32W T8	4200	110	≥50,000	4000K	>80

\*LPW per LM79 Report

#### Accessories and Replacement Parts

Item Number	Product Description
70132	Surface Mount Kit 1'x4'
70380	Surface Mount Kit 2'x2'
70381	Surface Mount Kit 2'x4'



# Volumetric Troffer

Ideal replacement for traditional fluorescent luminaires.



SYLVANIA Volumetric Troffers are energy saving, environmentally preferable LED alternatives to traditional fluorescent luminaires. Offered in two sizes with 3500K and 4000K color temperature options and luminous efficacy up to 138 LPW, both sizes are 0-10V dimmable down to 10% with optional emergency back-up. As a single piece luminaire, they are constructed with post painted sheet metal with UV stabilized polycarbonate diffuse curved lens and come with a 5-year warranty.

### Recommended applications

- Offices, conference rooms and classrooms
- Reception areas and foyers
- Corridors and elevators

### Product overview

- Single piece construction for quick and easy installation
- Same look as Retrofit Door Kit
- Slim design allowing for ample plenum access
- Energy savings of up to 55%
- Control ready for 0-10V dimming
- Rated life  $\geq 100,000$  hours ( $L_{70}$ ) ( $\geq 70,000$  for 2A versions)
- Listed for wet locations, covered ceiling mount only
- Wide operating temperature range  $-13^{\circ}\text{F}$  to  $+104^{\circ}\text{F}$   
EM:  $+32^{\circ}\text{F}$  to  $+104^{\circ}\text{F}$



\*For more details about which products are DLC Standard or DLC Premium, please visit pages 34-37.

## Savings in energy and costs over the LED lifetime per fixture\*\* LED vs. Traditional

	Energy consumption	Costs
Fluorescent 2x4 3x32T8 ISL equivalent - 75W	6,150 kWh	\$793
SYLVANIA LED 2x4 Volumetric - 42W	3,444 kWh	\$379
<b>SAVINGS</b>	<b>44%</b>	<b>\$414</b>

\*\*Energy costs based on \$0.11/kWh.

Traditional costs include energy cost, cost to replace lamps and ballast over the LED product life. LED cost does not include cost of the luminaire.

### 2x2 Volumetric Troffer

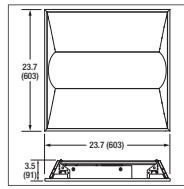

25W

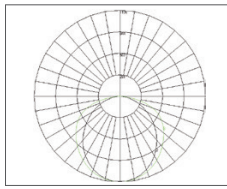

35W

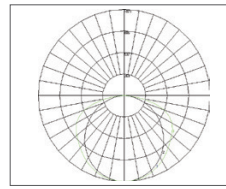

### Ordering Information

Item Number	Product Description	Power (W)	Input Voltage	Dimming	Replacement for up to	Total Fixture Lumens	LPW*	Rated Life L <sub>70</sub> (hours)	CCT	CRI
71725	2x2 Volumetric Troffer 25W 3500K	25W	120-277	0-10V	3x17W T8 / 2U31 T8	3200	134	≥70,000	3500K	>80
71727	2x2 Volumetric Troffer 25W 3500K, Emergency	25W	120-277	0-10V	3x17W T8 / 2U31 T8	3200	134	≥70,000	3500K	>80
71726	2x2 Volumetric Troffer 25W 4000K	25W	120-277	0-10V	3x17W T8 / 2U31 T8	3300	136	≥70,000	4000K	>80
71728	2x2 Volumetric Troffer 25W 4000K, Emergency	25W	120-277	0-10V	3x17W T8 / 2U31 T8	3300	136	≥70,000	4000K	>80
74352	2x2 Volumetric Troffer 35W 3500K	35W	120-277	0-10V	3x17W T8 / 2U31 T8	3500	107	≥100,000	3500K	>80
74354	2x2 Volumetric Troffer 35W 3500K, Emergency	35W	120-277	0-10V	3x17W T8 / 2U31 T8	3500	107	≥100,000	3500K	>80
74353	2x2 Volumetric Troffer 35W 4000K	35W	120-277	0-10V	3x17W T8 / 2U31 T8	3600	113	≥100,000	4000K	>80
74355	2x2 Volumetric Troffer 35W 4000K, Emergency	35W	120-277	0-10V	3x17W T8 / 2U31 T8	3600	113	≥100,000	4000K	>80

\*LPW per LM79 Report

### 2x4 Volumetric Troffer

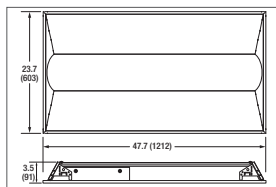

35W

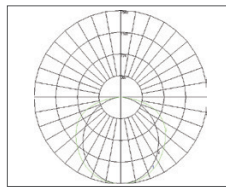

42W

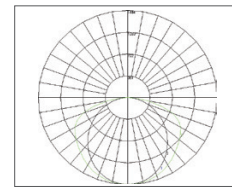

### Ordering Information

Item Number	Product Description	Power (W)	Input Voltage	Dimming	Replacement for up to	Total Fixture Lumens	LPW*	Rated Life L <sub>70</sub> (hours)	CCT	CRI
74309	2x4 Volumetric Troffer 35W 3500K	35W	120-277	0-10V	2x32W T8	4600	135	≥70,000	3500K	>80
74349	2x4 Volumetric Troffer 35W 3500K, Emergency	35W	120-277	0-10V	2x32W T8	4600	135	≥70,000	3500K	>80
74348	2x4 Volumetric Troffer 35W 4000K	35W	120-277	0-10V	2x32W T8	4600	138	≥70,000	4000K	>80
74356	2x4 Volumetric Troffer 35W 4000K, Emergency	35W	120-277	0-10V	2x32W T8	4600	138	≥70,000	4000K	>80
74441	2x4 Volumetric Troffer 42W 3500K	42W	120-277	0-10V	2x32W T8	4400	103	≥100,000	3500K	>80
74443	2x4 Volumetric Troffer 42W 3500K, Emergency	42W	120-277	0-10V	2x32W T8	4400	103	≥100,000	3500K	>80
74442	2x4 Volumetric Troffer 42W 4000K	42W	120-277	0-10V	2x32W T8	4400	103	≥100,000	4000K	>80
74444	2x4 Volumetric Troffer 42W 4000K, Emergency	42W	120-277	0-10V	2x32W T8	4400	103	≥100,000	4000K	>80

\*LPW per LM79 Report



# Retrofit Door Kit

Ideal replacement for traditional fluorescent lens troffers.



SYLVANIA Retrofit Door Kits are energy saving, environmentally preferable LED alternatives for retrofitting traditional fluorescent lens troffers. Offered in two sizes with 3500K and 4000K color temperature options and luminous efficacy up to 111 LPW, both sizes are 0-10V dimmable down to 10% with optional emergency back-up. The kits are easy to install with a single piece “door frame” and are constructed with post painted sheet metal with UV stabilized polycarbonate diffuse curved lens. They come with a 5-year warranty.

### Recommended applications

- Offices, conference rooms and classrooms
- Reception areas and foyers
- Corridors and elevators

### Product overview

- Single piece construction for quick and easy installation
- Improves vertical illuminance while minimizing glare
- Same look as the Volumetric Troffer
- Energy savings of up to 44%
- Controls ready with 0-10V dimming for additional energy savings
- Rated life  $\geq 82,000$  hours ( $L_{70}$ )
- Damp location rated
- Wide operating temperature range -13°F to +104°F  
EM: +32°F to +104°F



### Savings in energy and costs over the LED lifetime per fixture\* LED vs. Traditional

	Energy consumption	Costs
Fluorescent 2x4 3x32T8 ISL equivalent - 75W	6,150 kWh	\$793
SYLVANIA LED 2x4 Retrofit - 42W	3,444 kWh	\$379
<b>SAVINGS</b>	<b>44%</b>	<b>\$414</b>

\*Energy costs based on \$0.11/kWh.

Traditional costs include energy cost, cost to replace lamps and ballast over the LED product life. LED cost does not include cost of the luminaire.



## 2x2 Retrofit Door Kit

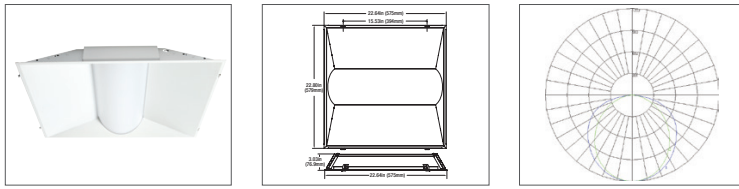

### Ordering Information

Item Number	Product Description	Power (W)	Input Voltage	Dimming	Replacement for up to	Total Fixture Lumens	LPW*	Rated Life L <sub>70</sub> (hours)	CCT	CRI
74265	2X2 Retrofit Door Kit 35W 3500K	35W	120-277	0-10V	3X17T8/2U31 T8	3400	105	≥82,000	3500K	>80
74267	2X2 Retrofit Door Kit 35W 3500K Emergency	35W	120-277	0-10V	3X17T8/2U31 T8	3400	105	≥82,000	3500K	>80
74266	2X2 Retrofit Door Kit 35W 4000K	35W	120-277	0-10V	3X17T8/2U31 T8	3500	104	≥82,000	4000K	>80
74268	2X2 Retrofit Door Kit 35W 4000K Emergency	35W	120-277	0-10V	3X17T8/2U31 T8	3500	104	≥82,000	4000K	>80

\*LPW per LM79 Report

## 2x4 Retrofit Door Kit

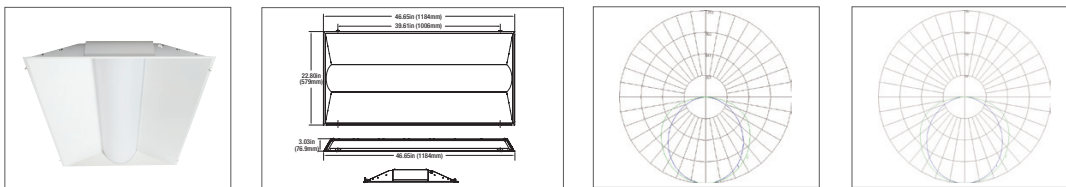

### Ordering Information

Item Number	Product Description	Power (W)	Input Voltage	Dimming	Replacement for up to	Total Fixture Lumens	LPW*	Rated Life L <sub>70</sub> (hours)	CCT	CRI
74256	2x4 Retrofit Door Kit 35W 3500K	35W	120-277	0-10V	2x28W T8/2x32W T8	3500	107	≥82,000	3500K	>80
74259	2x4 Retrofit Door Kit 35W 3500K Emergency	35W	120-277	0-10V	2x28W T8/2x32W T8	3500	107	≥82,000	3500K	>80
74255	2x4 Retrofit Door Kit 35W 4000K	35W	120-277	0-10V	2x28W T8/2x32W T8	3800	111	≥82,000	4000K	>80
74260	2x4 Retrofit Door Kit 35W 4000K Emergency	35W	120-277	0-10V	2x28W T8/2x32W T8	3800	111	≥82,000	4000K	>80
74258	2x4 Retrofit Door Kit 42W 3500K	42W	120-277	0-10V	3x28W T8/3x32W T8	4400	106	≥82,000	3500K	>80
74261	2x4 Retrofit Door Kit 42W 3500K Emergency	42W	120-277	0-10V	3x28W T8/3x32W T8	4400	106	≥82,000	3500K	>80
74257	2x4 Retrofit Door Kit 42W 4000K	42W	120-277	0-10V	3x28W T8/3x32W T8	4400	106	≥82,000	4000K	>80
74262	2x4 Retrofit Door Kit 42W 4000K Emergency	42W	120-277	0-10V	3x28W T8/3x32W T8	4400	106	≥82,000	4000K	>80

\*LPW per LM79 Report

### Compatibility

RDORKIT1A fixtures have been tested to perform properly with the following troffers:

- Lithonia Lighting® GT8
- Lithonia Lighting® SP8



# Troffer Retrofit Kit

Ideal replacement for traditional fluorescent lens troffers.

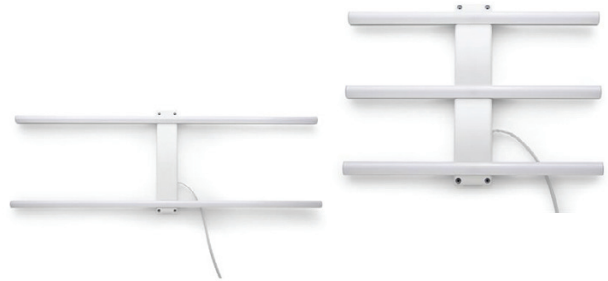

SYLVANIA Retrofit Troffer Kits are energy saving, environmentally preferable LED alternatives for retrofitting traditional fluorescent lens troffers. Offered in two sizes and two lamp configurations and three wattages/lumen packages with 3000K, 3500K, 4000K and 5000K color temperature options, both sizes are 0-10V dimmable down to 10% with luminous efficacy up to 125 LPW. The kits are easy to install and bypass the existing ballast to eliminate ballast incompatibility issues. They are constructed with lightweight extruded plastic and a white polycarbonate curved diffuse lens with a 120° beam angle. They come with a 5-year warranty.

### Product overview

- Extremely lightweight
- Easy installation in under 4 minutes
- Energy savings of up to 50%
- Controls ready with 0-10V dimming for additional energy savings
- Rated life  $\geq 50,000$  hours ( $L_{70}$ )
- Wide operating temperature range  $-4^{\circ}\text{F}$  to  $+122^{\circ}\text{F}$

### Recommended applications

- Education facilities
- Offices and conference rooms
- Retail and commercial spaces



\*For more details about which products are DLC Standard, please visit pages 34-37.

### Savings in energy and costs over the LED lifetime per fixture\*\* LED vs. Traditional

	Energy consumption	Costs
Fluorescent 2x4 3x32T8 ISL equivalent - 73W	4,300 kWh	\$568
SYLVANIA LED 2x4 3-lamp Retrofit - 44W	2,200 kWh	\$242
<b>SAVINGS</b>	<b>49%</b>	<b>\$326</b>

\*\*Energy costs based on \$0.11/kWh.

Traditional costs include energy cost, cost to replace lamps and ballast over the LED product life. LED cost does not include cost of the luminaire.

### 2x2 Troffer Retrofit Kit

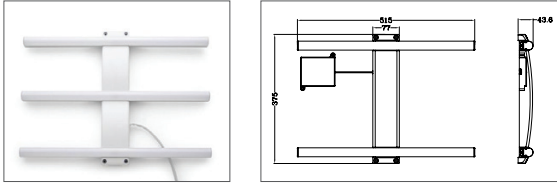

#### Ordering Information

Item Number	Product Description	Power (W)	Input Voltage	Dimming	Replacement for up to	Total Fixture Lumens	LPW*	Rated Life L <sub>70</sub> (hours)	CCT	CRI
75460	2X2 Retrofit Kit 2-lamp 24W 3000K	24W	120-277	0-10V	2x17W T8 ISN	3000	125	≥50,000	3000K	82
75461	2X2 Retrofit Kit 2-lamp 24W 3500K	24W	120-277	0-10V	2x17W T8 ISN	3000	125	≥50,000	3500K	82
75462	2X2 Retrofit Kit 2-lamp 24W 4000K	24W	120-277	0-10V	2x17W T8 ISN	3000	125	≥50,000	4000K	82
75463	2X2 Retrofit Kit 2-lamp 24W 5000K	24W	120-277	0-10V	2x17W T8 ISN	3000	125	≥50,000	5000K	82
75431	2X2 Retrofit Kit 3-lamp 26W 3000K	26W	120-277	0-10V	3x17W T8 ISN	3200	123	≥50,000	3000K	82
75432	2X2 Retrofit Kit 3-lamp 26W 3500K	26W	120-277	0-10V	3x17W T8 ISN	3200	123	≥50,000	3500K	82
75433	2X2 Retrofit Kit 3-lamp 26W 4000K	26W	120-277	0-10V	3x17W T8 ISN	3200	123	≥50,000	4000K	82
75434	2X2 Retrofit Kit 3-lamp 26W 5000K	26W	120-277	0-10V	3x17W T8 ISN	3200	123	≥50,000	5000K	82
75276	2X2 Retrofit Kit 2-lamp 27W 3000K	27W	120-277	0-10V	2X17W T8 ISN	3000	111	≥50,000	3000K	82
75277	2X2 Retrofit Kit 2-lamp 27W 3500K	27W	120-277	0-10V	2X17W T8 ISN	3000	111	≥50,000	3500K	82
75278	2X2 Retrofit Kit 2-lamp 27W 4000K	27W	120-277	0-10V	2X17W T8 ISN	3000	111	≥50,000	4000K	82
75279	2X2 Retrofit Kit 2-lamp 27W 5000K	27W	120-277	0-10V	2X17W T8 ISN	3000	111	≥50,000	5000K	82
75056	2X2 Retrofit Kit 3-lamp 29W 3000K	29W	120-277	0-10V	3X17W T8 ISN	3200	110	≥50,000	3000K	82
75057	2X2 Retrofit Kit 3-lamp 29W 3500K	29W	120-277	0-10V	3X17W T8 ISN	3200	110	≥50,000	3500K	82
75058	2X2 Retrofit Kit 3-lamp 29W 4000K	29W	120-277	0-10V	3X17W T8 ISN	3200	110	≥50,000	4000K	82
75059	2X2 Retrofit Kit 3-lamp 29W 5000K	29W	120-277	0-10V	3X17W T8 ISN	3200	110	≥50,000	5000K	82

\*LPW per LM79 Report

### 2x4 Troffer Retrofit Kit

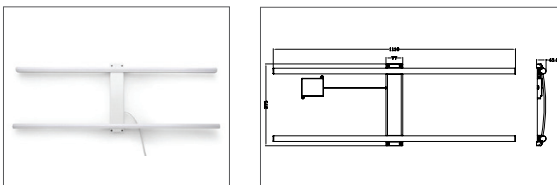

#### Ordering Information

Item Number	Product Description	Power (W)	Input Voltage	Dimming	Replacement for up to	Total Fixture Lumens	LPW*	Rated Life L <sub>70</sub> (hours)	CCT	CRI
75427	2X4 Retrofit Kit 2-lamp 27W 3000K	27W	120-277	0-10V	2x32W T8 ISL	3200	119	≥50,000	3000K	82
75428	2X4 Retrofit Kit 2-lamp 27W 3500K	27W	120-277	0-10V	2x32W T8 ISL	3200	119	≥50,000	3500K	82
75429	2X4 Retrofit Kit 2-lamp 27W 4000K	27W	120-277	0-10V	2x32W T8 ISL	3200	119	≥50,000	4000K	82
75430	2X4 Retrofit Kit 2-lamp 27W 5000K	27W	120-277	0-10V	2x32W T8 ISL	3200	119	≥50,000	5000K	82
75051	2X4 Retrofit Kit 2-lamp 29W 3000K	29W	120-277	0-10V	2X32W T8 ISL	3200	110	≥50,000	3000K	82
75052	2X4 Retrofit Kit 2-lamp 29W 3500K	29W	120-277	0-10V	2X32W T8 ISL	3200	110	≥50,000	3500K	82
75053	2X4 Retrofit Kit 2-lamp 29W 4000K	29W	120-277	0-10V	2X32W T8 ISL	3200	110	≥50,000	4000K	82
75054	2X4 Retrofit Kit 2-lamp 29W 5000K	29W	120-277	0-10V	2X28W T8 ISL	3200	110	≥50,000	5000K	82
75496	2X4 Retrofit Kit 3-lamp 40W 3000K	40W	120-277	0-10V	3x32W T8 ISL	4800	120	≥50,000	3000K	82
75497	2X4 Retrofit Kit 3-lamp 40W 3500K	40W	120-277	0-10V	3x32W T8 ISL	4800	120	≥50,000	3500K	82
75498	2X4 Retrofit Kit 3-lamp 40W 4000K	40W	120-277	0-10V	3x32W T8 ISL	4800	120	≥50,000	4000K	82
75499	2X4 Retrofit Kit 3-lamp 40W 5000K	40W	120-277	0-10V	3x32W T8 ISL	4800	120	≥50,000	5000K	82
75234	2X4 Retrofit Kit 3-lamp 44W 3000K	44W	120-277	0-10V	3X32W T8 ISL	4850	110	≥50,000	3000K	82
75235	2X4 Retrofit Kit 3-lamp 44W 3500K	44W	120-277	0-10V	3X32W T8 ISL	4850	110	≥50,000	3500K	82
75236	2X4 Retrofit Kit 3-lamp 44W 4000K	44W	120-277	0-10V	3X32W T8 ISL	4850	110	≥50,000	4000K	82
75237	2X4 Retrofit Kit 3-lamp 44W 5000K	44W	120-277	0-10V	3X32W T8 ISL	4850	110	≥50,000	5000K	82

\*LPW per LM79 Report



# Surface Mount Series

Ideal replacement for traditional incandescent or compact fluorescent luminaires.

SYLVANIA Surface Mount Series are energy saving, environmentally preferable LED alternatives to traditional CFL or incandescent luminaires. Offered in 2700K, 3000K and 4000K color temperature options and low wattages, these luminaires are dimmable on compatible phase-cut dimmers. Designs range from traditional to modern to meet everyday application needs. All come with a 5-year warranty.

### Recommended applications

- Hospitality
- Property management and education facilities
- Residential and assisted living

### Product overview

- Traditional and modern designs
- Soft, uniform illumination
- Easy installation
- Energy savings of up to 75%
- Additional energy savings when dimmed
- Rated life  $\geq 35,000$  hours ( $L_{70}$ )
- Wide operating temperature range  $-4^{\circ}\text{F}$  to  $+104^{\circ}\text{F}$



\*Please refer to the ordering guide on pages 34-37 for products applicable with ENERGY STAR

### Savings in energy and costs over the LED lifetime per fixture\*\* LED vs. Traditional

	Energy consumption	Costs
<b>Incandescent 100W A19 equivalent</b>	5,000 kWh	\$630
<b>SYLVANIA LED Surface - 25W</b>	1,250 kWh	\$138
<b>SAVINGS</b>	<b>75%</b>	<b>\$492</b>

\*\*Energy costs based on \$0.11/kWh.

Traditional costs include energy cost, cost to replace lamps and ballast over the LED product life. LED cost does not include cost of the luminaire.

### Surface Mount Round

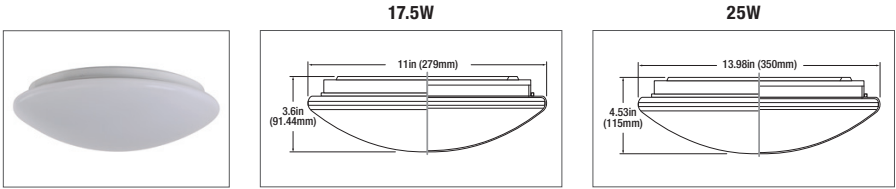

### Ordering Information

Item Number	Product Description	Power (W)	Input Voltage	Dimming	Replacement for up to	Total Fixture Lumens	LPW*	Rated Life L <sub>70</sub> (hours)	CCT	CRI
74305	Surface Round 17.5W 2700K, 11"	17.5	120	Phase-cut	75W INC	1000	57	≥35,000	2700K	>80
74306	Surface Round 17.5W 4000K, 11"	17.5	120	Phase-cut	75W INC	1200	68	≥35,000	4000K	>80
74263	Surface Round 25W 2700K, 14"	25	120	Phase-cut	1x32W CFL/100W INC	1500	60	≥50,000	2700K	>80
74264	Surface Round 25W 4000K, 14"	25	120	Phase-cut	1x32W CFL/100W INC	1600	65	≥50,000	4000K	>80

\*LPW per LM79 Report

### Surface Mount Square

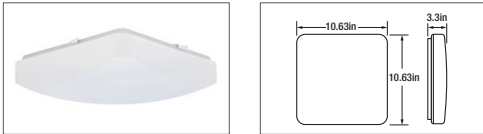

### Ordering Information

Item Number	Product Description	Power (W)	Input Voltage	Dimming	Replacement for up to	Total Fixture Lumens	LPW*	Rated Life L <sub>70</sub> (hours)	CCT	CRI
74303	Surface Square 17.5W 2700K, 11"	17.5	120	Phase-cut	up to 75W INC	1000	57	≥35,000	2700K	>80
74304	Surface Square 17.5W 4000K, 11"	17.5	120	Phase-cut	up to 75W INC	1200	68	≥35,000	4000K	>80

\*LPW per LM79 Report

### 11" LED Flush Mount



### Ordering Information

Item Number	Product Description	Power (W)	Input Voltage	Dimming	Replacement for up to	Total Fixture Lumens	LPW*	Rated Life L <sub>70</sub> (hours)	CCT	CRI
71500	LED Flush Mount 15W 3000K, 11"	15	120	Phase-cut	75W INC	1000	67	≥50,000	3000K	>80
71505	LED Flush Mount 15W 4000K, 11"	15	120	Phase-cut	75W INC	1000	67	≥50,000	4000K	>80

\*LPW per LM79 Report

### LED Round Flush Mount



### Ordering Information

Item Number	Product Description	Power (W)	Input Voltage	Dimming	Replacement for up to	Total Fixture Lumens	LPW*	Rated Life L <sub>70</sub> (hours)	CCT	CRI
71403	LED Round Flush Mount 15W 3000K, 10"	15	120	Phase-cut	75W INC	1000	67	≥50,000	3000K	>80
71404	LED Round Flush Mount 15W 4000K, 10"	15	120	Phase-cut	75W INC	1000	67	≥50,000	4000K	>80
71405	LED Round Flush Mount 15W 3000K, 12"	15	120	Phase-cut	75W INC	1000	67	≥50,000	3000K	>80
71406	LED Round Flush Mount 15W 4000K, 12"	15	120	Phase-cut	75W INC	1000	67	≥50,000	4000K	>80

\*LPW per LM79 Report

### LED 15" Flush Mount



#### Ordering Information

Item Number	Product Description	Power (W)	Input Voltage	Dimming	Replacement for up to	Total Fixture Lumens	LPW*	Rated Life L <sub>70</sub> (hours)	CCT	CRI
72517	LED Flush Mount 26W 4000K, 15"	26	120	Phase-cut	75W INC	1800	69	≥35,000	4000K	>80

\*LPW per LM79 Report

### LED Flush Mount Cloud with Trim

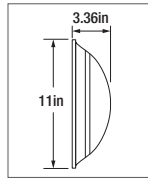

#### Ordering Information

Item Number	Product Description	Power (W)	Input Voltage	Dimming	Replacement for up to	Total Fixture Lumens	LPW*	Rated Life L <sub>70</sub> (hours)	CCT	CRI
74307	LED Flush Mount Cloud with Trim 15W 2700K, 11"	21	120	Phase-cut	75W INC	1000	47	≥35,000	2700K	>80
74308	LED Flush Mount Cloud with Trim 15W 4000K, 11"	21	120	Phase-cut	75W INC	1200	57	≥35,000	4000K	>80

\*LPW per LM79 Report

### LED Traditional Ceiling Dome

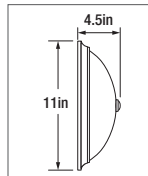

#### Ordering Information

Item Number	Product Description	Power (W)	Input Voltage	Dimming	Replacement for up to	Total Fixture Lumens	LPW*	Rated Life L <sub>70</sub> (hours)	CCT	CRI
74302	Traditional Ceiling Dome 15W 3000K, 11"	21	120	Phase-cut	75W INC	1000	47	≥35,000	2700K	>80

\*LPW per LM79 Report

### Dimming Compatibility List

Brand	Model Number
Legrand (Pass and SEYMOUR)	HCL453PW
Lutron	MACL-153M-WH
Lutron	MAELV-600-WH
Lutron	SCL-153-WH
Lutron	PD-WCL-WH



## Undercabinet and PenduLum®

### Slim Convertible LED Undercabinet Light

SYLVANIA Slim Convertible Undercabinet Lights are energy saving, environmentally preferable LED alternatives to traditional fluorescent luminaires. They are designed with a ½" low profile housing and the options of plug in or hardwire, so you can add light anywhere you need it. Offered in 3000K color temperature, low wattages and four lengths, these luminaires are dimmable on compatible phase-cut dimmers. Comes with a 5-year warranty.



### Ordering Information

Item Number	Product Description	Power (W)	Input Voltage	Dimming	Replacement for up to	Total Fixture Lumens	LPW*	Rated Life L <sub>70</sub> (hours)	CCT	CRI
74347	Slim Undercabinet Light 4.5W 2700K, 9"	4.5	120	Phase-cut	up to 15W INC	352	82	≥35,000	3000K	>80
74346	Slim Undercabinet Light 6W 2700K, 12"	6	120	Phase-cut	up to 25W INC	406	71	≥35,000	3000K	>80
74345	Slim Undercabinet Light 8W 2700K, 18"	8	120	Phase-cut	up to 30W INC	626	82	≥35,000	3000K	>80
74344	Slim Undercabinet Light 10W 2700K, 24"	10	120	Phase-cut	up to 40W INC	756	78	≥35,000	3000K	>80

\*LPW per LM79 Report

### PenduLum

The PenduLum is a pendant luminaire that has multiple mounting configurations due to an adjustable cord and tether. Offered in two colors, the pendant can be paired with any medium base lamp up to 60W. The design of the intended application can be changed in a split second when you install one or multiple of these fixtures. Comes with a 1-year warranty.



### Ordering Information

Item Number	Product Description	Power (W) (Lamp not included)	Input Voltage	Dimming	Textile Cord Length	Tether Cord Length	Canopy Diameter	Color
74279	PenduLum, Oil Rubbed Bronze	Up to 60W	120	Phase-cut	6.5 ft	5 ft	4.5 in	Oil Rubbed Bronze
74280	PenduLum, Brushed Nickel	Up to 60W	120	Phase-cut	6.5 ft	5 ft	4.5 in	Brushed Nickel



# High Bay

Ideal replacement for traditional HID luminaires.



SYLVANIA High Bay luminaires are energy saving, environmentally preferable LED alternatives to traditional HID luminaires and are offered in three wattages and lumen packages with 4000K and 5000K color temperature options with luminous efficacy up to 123 LPW. All luminaires are 0-10V dimmable down to 16%. With a traditional design, these luminaires are constructed with two-piece cast aluminum alloy housing with powder coated paint finish and UV stabilized polycarbonate refractor or aluminum reflector with Type V distribution. They come with a 5-year warranty.

### Recommended applications

- Warehouse and manufacturing facilities
- Gymsnasiums and indoor arenas
- Big box retail and loading docks

### Product overview

- Lightweight luminaire
- Two optic options (refractor or reflector)
- Energy savings of up to 67%
- Controls ready with 0-10V dimming for additional energy savings
- $\geq 63,000$  hours ( $L_{70}$ ) (100W and 347V versions),  $\geq 73,000$  hours (300W versions),  $\geq 150,000$  hours (200W and HUV version)
- Damp location rated
- Wide operating temperature range -40°F to +104°F



### Savings in energy and costs over the LED lifetime per fixture\* LED vs. Traditional

	Energy consumption	Costs
Metal Halide 400W equivalent - 450W	22,500 kWh	\$2,696
SYLVANIA LED High Bay - 200W	10,000 kWh	\$1,100
<b>SAVINGS</b>	<b>56%</b>	<b>\$1,596</b>

\*Energy costs based on \$0.11/kWh.

Traditional costs include energy cost, cost to replace lamps and ballast over the LED product life. LED cost does not include cost of the luminaire.

Energy savings are based on High Bay housing with refractor.



High Bay

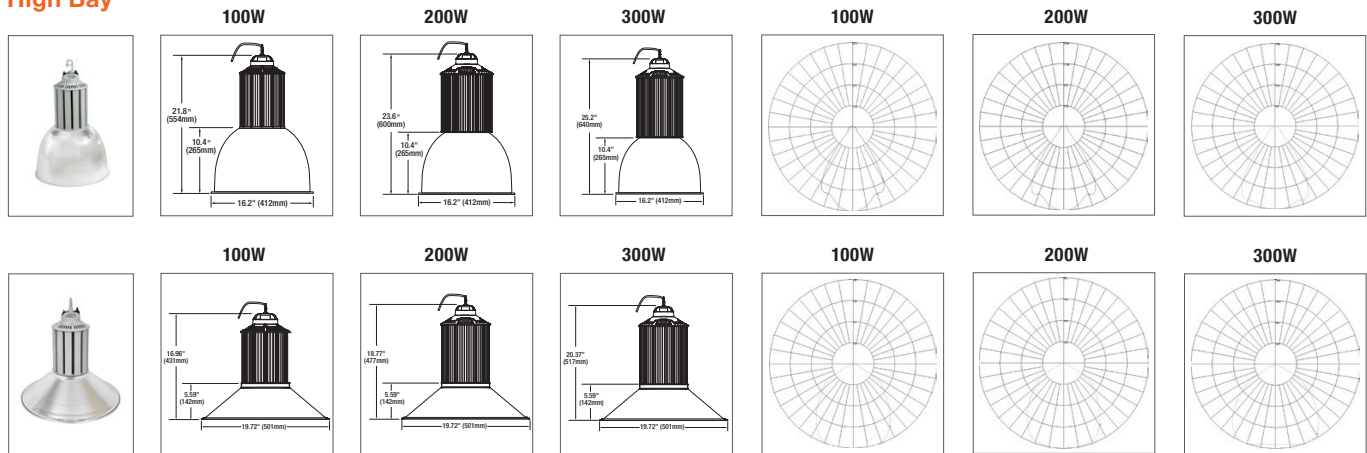

Ordering Information (120-277V)

Item Number	Product Description	Power (W)	Input Voltage	Dimming	Replacement for up to	Total Fixture Lumens	LPW*	Rated Life L <sub>70</sub> (hours)	CCT	CRI
74230	High Bay UNV 100W 4000K	100W	120-277	0-10V	250W MH/HPS	10,800	108	≥63,000	4000K	>80
74231	High Bay UNV 100W 5000K	100W	120-277	0-10V	250W MH/HPS	10,800	108	≥63,000	5000K	>80
74232	High Bay UNV 200W 4000K	200W	120-277	0-10V	400W MH/HPS	22,200	114	≥150,000	4000K	>80
74233	High Bay UNV 200W 5000K	200W	120-277	0-10V	400W MH/HPS	22,500	115	≥150,000	5000K	>80
71731	High Bay UNV 300W 4000K	300W	120-277	0-10V	1000W MH/HPS	29,600	103	≥73,000	4000K	>80
71732	High Bay UNV 300W 5000K	300W	120-277	0-10V	1000W MH/HPS	30,300	104	≥73,000	5000K	>80

\*LPW per LM79 Report  
 \*\*Lumens and LPW are based on housing with refractor

Ordering Information (347V, 347-480V)

Item Number	Product Description	Power (W)	Input Voltage	Dimming	Replacement for up to	Total Fixture Lumens	LPW*	Rated Life L <sub>70</sub> (hours)	CCT	CRI
74269	High Bay 347V 100W 4000K	100W	347	0-10V	250W MH/HPS	10,800	108	≥63,000	4000K	>80
74272	High Bay 347V 200W 5000K	200W	347	0-10V	400W MH/HPS	20,600	103	≥63,000	5000K	>80
74509	High Bay HUV 100W 4000K	100W	HUV	0-10V	250W MH/HPS	10,800	108	≥150,000	4000K	>80
74510	High Bay HUV 100W 5000K	100W	HUV	0-10V	250W MH/HPS	10,800	108	≥150,000	5000K	>80
74511	High Bay HUV 200W 4000K	200W	HUV	0-10V	400W MH/HPS	23,300	123	≥150,000	4000K	>80
74512	High Bay HUV 200W 5000K	200W	HUV	0-10V	400W MH/HPS	23,100	122	≥150,000	5000K	>80

\*LPW per LM79 Report  
 \*\*Lumens and LPW are based on housing with refractor

Ordering Information (Optics)

Optics (B or C)

Item Number	Product Description	Optic
74234	16 inch Polycarbonate Refractor (IK08)	B
74395	20 inch Aluminum Reflector	C

Housing (A) + Optics (B or C) =

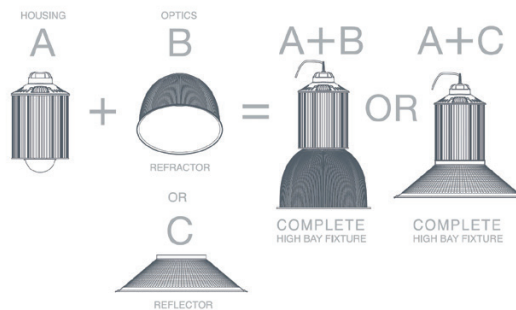

Accessories and Replacement Parts

Item Number	Product Description
74449	Bottom Lens for Refractor



# Linear High Bay

Ideal replacement for traditional linear fluorescent and HID luminaires



SYLVANIA Linear High Bay luminaires are energy saving and environmentally preferable LED alternatives to traditional linear fluorescent and HID luminaires. They are offered in four wattages with 4000K and 5000K color temperature options with luminous efficacy up to 133 LPW. All luminaires are 0-10V dimmable down to 10%. With a linear design, these luminaires are constructed with a LED hanging tray to accommodate an easy installation and aisle or wide optic options for adapting to many applications. They come with a 5-year warranty.

### Recommended applications

- Warehouse and manufacturing facilities
- Gymnasiums and indoor arenas
- Big box retail and loading docks

### Product overview

- Lightweight luminaire
- Two optic options (aisle or wide)
- Energy savings of up to 66%
- Controls ready with 0-10V dimming and optional sensors for additional energy savings
- Rated life  $\geq 80,000$  hours ( $L_{70}$ ) (100W, 165W and 225W versions),  $\geq 100,000$  (150W versions)
- Damp location rated
- Wide operating temperature range  $-40^{\circ}\text{F}$  to  $+131^{\circ}\text{F}$



\*For more details about which products are DLC Standard or DLC Premium, please visit pages 34-37.

### Savings in energy and costs over the LED lifetime per fixture\*\* LED vs. Traditional

	Energy consumption	Costs
Metal Halide 400W equivalent - 450W	36,000 kWh	\$4,216
SYLVANIA LED Linear High Bay - 225W	18,000 kWh	\$1,980
<b>SAVINGS</b>	<b>50%</b>	<b>\$2,236</b>

\*\*Energy costs based on \$0.11/kWh.

Traditional costs include energy cost, cost to replace lamps and ballast over the LED product life. LED cost does not include cost of the luminaire.

Energy savings are based on High Bay housing with refractor.

Linear High Bay

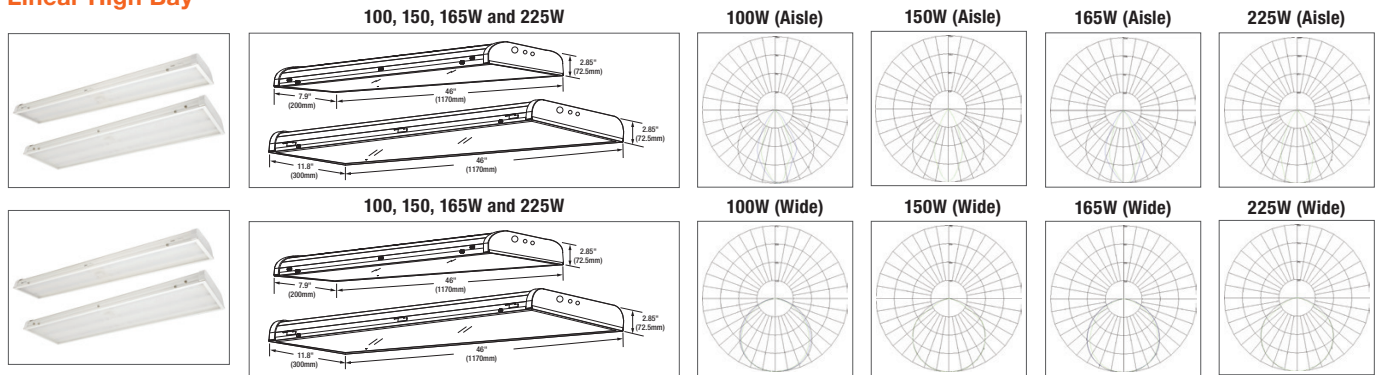

Ordering Information (Aisle Distribution)

Item Number	Product Description	Power (W)	Input Voltage	Dimming	Replacement for up to	Total Fixture Lumens	LPW*	Rated Life L <sub>70</sub> (hours)	CCT	CRI
74839	Linear High Bay UNV 100W 4000K Aisle	100W	120-277V	0-10V	250W MH/HPS	13,000	127	≥80,000	4000K	>80
74840	Linear High Bay UNV 100W 5000K Aisle	100W	120-277V	0-10V	250W MH/HPS	13,000	127	≥80,000	5000K	>80
74843	Linear High Bay UNV 100W 4000K Aisle, Sensor (MTO)	100W	120-277V	0-10V	250W MH/HPS	13,000	127	≥80,000	4000K	>80
74844	Linear High Bay UNV 100W 5000K Aisle, Sensor (MTO)	100W	120-277V	0-10V	250W MH/HPS	13,000	127	≥80,000	5000K	>80
74847	Linear High Bay UNV 150W 4000K Aisle (MTO)	150W	120-277V	0-10V	250W MH/320W HPS	19,100	130	≥100,000	4000K	>80
74848	Linear High Bay UNV 150W 5000K Aisle (MTO)	150W	120-277V	0-10V	250W MH/320W HPS	19,100	130	≥100,000	5000K	>80
74853	Linear High Bay UNV 150W 4000K Aisle, Sensor (MTO)	150W	120-277V	0-10V	250W MH/320W HPS	19,100	130	≥100,000	4000K	>80
74905	Linear High Bay UNV 150W 5000K Aisle, Sensor (MTO)	150W	120-277V	0-10V	250W MH/320W HPS	19,100	130	≥100,000	5000K	>80
74831	Linear High Bay UNV 165W 4000K Aisle	165W	120-277V	0-10V	250W MH/320W HPS	18,900	117	≥80,000	4000K	>80
74832	Linear High Bay UNV 165W 5000K Aisle	165W	120-277V	0-10V	250W MH/320W HPS	18,900	117	≥80,000	5000K	>80
74835	Linear High Bay UNV 165W 4000K Aisle, Sensor (MTO)	165W	120-277V	0-10V	250W MH/320W HPS	18,900	117	≥80,000	4000K	>80
74836	Linear High Bay UNV 165W 5000K Aisle, Sensor (MTO)	165W	120-277V	0-10V	250W MH/320W HPS	18,900	117	≥80,000	5000K	>80
74823	Linear High Bay UNV 225W 4000K Aisle	225W	120-277V	0-10V	400W MH/HPS	25,300	112	≥80,000	4000K	>80
74824	Linear High Bay UNV 225W 5000K Aisle	225W	120-277V	0-10V	400W MH/HPS	25,300	112	≥80,000	5000K	>80
74827	Linear High Bay UNV 225W 4000K Aisle, Sensor (MTO)	225W	120-277V	0-10V	400W MH/HPS	25,300	112	≥80,000	4000K	>80
74828	Linear High Bay UNV 225W 5000K Aisle, Sensor (MTO)	225W	120-277V	0-10V	400W MH/HPS	25,300	112	≥80,000	5000K	>80

\*LPW per LM79 Report (MTO) = Made to Order

Ordering Information (Wide Distribution)

Item Number	Product Description	Power (W)	Input Voltage	Dimming	Replacement for up to	Total Fixture Lumens	LPW*	Rated Life L <sub>70</sub> (hours)	CCT	CRI
74837	Linear High Bay UNV 100W 4000K Wide	100W	120-277V	0-10V	250W MH/HPS	12,900	127	≥80,000	4000K	>80
74838	Linear High Bay UNV 100W 5000K Wide	100W	120-277V	0-10V	250W MH/HPS	12,900	127	≥80,000	5000K	>80
74841	Linear High Bay UNV 100W 4000K Wide, Sensor (MTO)	100W	120-277V	0-10V	250W MH/HPS	12,900	127	≥80,000	4000K	>80
74842	Linear High Bay UNV 100W 5000K Wide, Sensor (MTO)	100W	120-277V	0-10V	250W MH/HPS	12,900	127	≥80,000	5000K	>80
74845	Linear High Bay UNV 150W 4000K Wide	150W	120-277V	0-10V	250W MH/320W HPS	19,700	133	≥100,000	4000K	>80
74846	Linear High Bay UNV 150W 5000K Wide	150W	120-277V	0-10V	250W MH/320W HPS	19,700	133	≥100,000	5000K	>80
74849	Linear High Bay UNV 150W 4000K Wide, Sensor (MTO)	150W	120-277V	0-10V	250W MH/320W HPS	19,700	133	≥100,000	4000K	>80
74850	Linear High Bay UNV 150W 5000K Wide, Sensor (MTO)	150W	120-277V	0-10V	250W MH/320W HPS	19,700	133	≥100,000	5000K	>80
74829	Linear High Bay UNV 165W 4000K Wide	165W	120-277V	0-10V	250W MH/320W HPS	18,100	112	≥80,000	4000K	>80
74830	Linear High Bay UNV 165W 5000K Wide	165W	120-277V	0-10V	250W MH/320W HPS	18,100	112	≥80,000	5000K	>80
74833	Linear High Bay UNV 165W 4000K Wide, Sensor (MTO)	165W	120-277V	0-10V	250W MH/320W HPS	18,100	112	≥80,000	4000K	>80
74834	Linear High Bay UNV 165W 5000K Wide, Sensor (MTO)	165W	120-277V	0-10V	250W MH/320W HPS	18,100	112	≥80,000	5000K	>80
74821	Linear High Bay UNV 225W 4000K Wide	225W	120-277V	0-10V	400W MH/HPS	26,600	117	≥80,000	4000K	>80
74822	Linear High Bay UNV 225W 5000K Wide	225W	120-277V	0-10V	400W MH/HPS	26,600	117	≥80,000	5000K	>80
74825	Linear High Bay UNV 225W 4000K Wide, Sensor (MTO)	225W	120-277V	0-10V	400W MH/HPS	26,600	117	≥80,000	4000K	>80
74826	Linear High Bay UNV 225W 5000K Wide, Sensor (MTO)	225W	120-277V	0-10V	400W MH/HPS	26,600	117	≥80,000	5000K	>80

\*LPW per LM79 Report (MTO) = Made to Order

Accessories and Replacement Parts

Item Number	Product Description
71758	Sensor Remote
74597	Wire Guard for 100W, 150W, and 165W versions
74598	Wire Guard for 225W versions

100W, 150W, 165W Wire Guard

225W Wire Guard

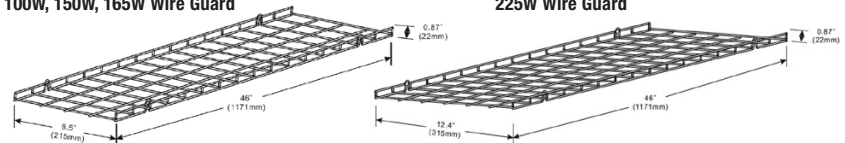



# Vapor Tight

Ideal replacement for traditional linear HID and fluorescent luminaires.

SYLVANIA IP65 rated Vapor Tight luminaires are energy saving, environmentally preferable LED alternatives to traditional fluorescent and HID luminaires and are offered in two sizes, 4000K and 5000K color temperatures with luminous efficacy up to 140 LPW. All luminaires are 0-10V dimmable down to 6% with optional sensors and/or emergency back-up. These luminaires deliver a Type V distribution and are constructed with a one-piece polycarbonate housing and one-piece clear etched polycarbonate lens. They come with a 5-year warranty.

### Recommended applications

- Canopies and outdoor walkways
- Garages and stairwells
- Industrial and pool areas



### Product overview

- IP65 rated for use in applications requiring a wash down or in a wet environment
- ETL sanitation listed for NSF splash zones
- Hanging cable included for easy installation
- Energy savings of up to 56% over traditional fluorescent and HID luminaires
- Controls ready with 0-10V dimming and optional sensors for additional energy savings
- Rated life  $\geq 66,000$  hours ( $L_{70}$ ) (1A UNV versions),  $\geq 84,000$  hours (1A HUV versions), and  $\geq 120,000$  hours (1B and 25W 1A versions)
- Instant on/instant restrike
- Wide operating temperature  $-40^{\circ}\text{F}$  to  $+104^{\circ}\text{F}$   
EM:  $+14^{\circ}\text{F}$  to  $+104^{\circ}\text{F}$



\*For more details about which products are DLC Standard or DLC Premium, please visit pages 34-37.

### Savings in energy and costs over the LED lifetime per fixture\*\* LED vs. Traditional

	Energy consumption	Costs
Fluorescent 1-F96T12 equivalent - 86W	5,848 kWh	\$826
SYLVANIA LED Vapor Tight - 50W	3,400 kWh	\$374
<b>SAVINGS</b>	<b>42%</b>	<b>\$452</b>

\*\*Energy costs based on \$0.11/kWh.

Traditional costs include energy cost, cost to replace lamps and ballast over the LED product life. LED cost does not include cost of the luminaire.

## Vapor Tight

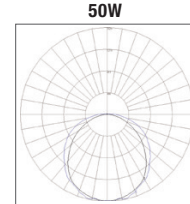
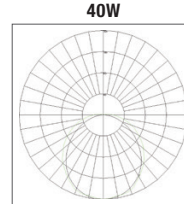
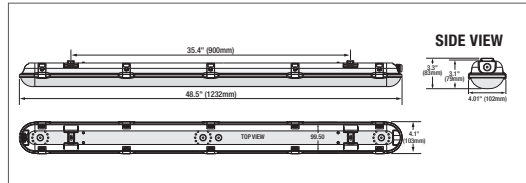
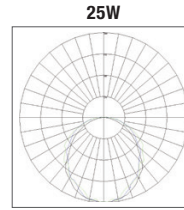
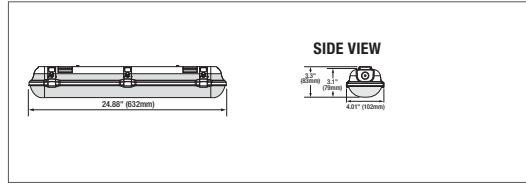

### Ordering Information (2ft, 120-277V)

Item Number	Product Description	Power (W)	Input Voltage	Dimming	Replacement for up to	Total Fixture Lumens*	LPW*	Rated Life L <sub>70</sub> (hours)	CCT	CRI
74530	Vapor Tight UNV 25W 4000K	25	120-277V	0-10V	2 F32 T8 / 70W HPS	3100	135	≥122,000	4000K	>80
74531	Vapor Tight UNV 25W 5000K	25	120-277V	0-10V	2 F32 T8 / 70W HPS	3100	137	≥122,000	5000K	>80

\*Lumens and LPW based on housing with etched lens. LPW per LM79 Report.

### Ordering Information (4ft, 120-277V)

Item Number	Product Description	Power (W)	Input Voltage	Dimming	Replacement for up to	Total Fixture Lumens*	LPW*	Rated Life L <sub>70</sub> (hours)	CCT	CRI
74376	Vapor Tight UNV 40W 4000K	40W	120-277V	0-10V	2 F32 T8 / 1 F96 T12	5300	139	≥120,000	4000K	>80
74378	Vapor Tight UNV 40W 4000K, Sensor	40W	120-277V	0-10V	2 F32 T8 / 1 F96 T12	5400	140	≥120,000	4000K	>80
74554	Vapor Tight UNV 40W 4000K, Emergency	40W	120-277V	0-10V	2 F32 T8 / 1 F96 T12	5300	139	≥120,000	4000K	>80
74556	Vapor Tight UNV 40W 4000K, Sensor, Emergency	40W	120-277V	0-10V	2 F32 T8 / 1 F96 T12	5400	140	≥120,000	4000K	>80
74377	Vapor Tight UNV 40W 5000K	40W	120-277V	0-10V	2 F32 T8 / 1 F96 T12	5300	137	≥120,000	5000K	>80
74379	Vapor Tight UNV 40W 5000K, Sensor	40W	120-277V	0-10V	2 F32 T8 / 1 F96 T12	5400	137	≥120,000	5000K	>80
74555	Vapor Tight UNV 40W 5000K, Emergency	40W	120-277V	0-10V	2 F32 T8 / 1 F96 T12	5300	137	≥120,000	5000K	>80
74557	Vapor Tight UNV 40W 5000K, Sensor, Emergency	40W	120-277V	0-10V	2 F32 T8 / 1 F96 T12	5400	137	≥120,000	5000K	>80
74224	Vapor Tight UNV 50W 4000K, Sensor	50W	120-277V	0-10V	2 F32 T8 / 1 F96 T12	5000	102	≥68,000	4000K	>80
74225	Vapor Tight UNV 50W 5000K, Sensor	50W	120-277V	0-10V	2 F32 T8 / 1 F96 T12	5000	103	≥67,000	5000K	>80
74227	Vapor Tight UNV 50W 5000K, Emergency	50W	120-277V	0-10V	2 F32 T8 / 1 F96 T12	5000	103	≥66,000	5000K	>80

\*Lumens and LPW based on housing with etched lens. LPW per LM79 Report.

### Ordering Information (4ft, 347-480V)

Item Number	Product Description	Power (W)	Input Voltage	Dimming	Replacement for up to	Total Fixture Lumens*	LPW*	Rated Life L <sub>70</sub> (hours)	CCT	CRI
74552	Vapor Tight HUV 50W 4000K	50W	347-480V	0-10V	2 F32 T8 / 1 F96 T12	5700	111	≥84,000	4000K	>80
74553	Vapor Tight HUV 50W 5000K	50W	347-480V	0-10V	2 F32 T8 / 1 F96 T12	5700	111	≥84,000	5000K	>80

\*Lumens and LPW based on housing with etched lens. LPW per LM79 Report.

### Accessories and Replacement Parts

Item Number	Product Description
74310	Vapor Tight Sensor Remote for Vapor 1A
74541	Vapor Tight Sensor Remote for Vapor 1B
74920	Tandem Wiring Connector
74448	4ft Polycarbonate Replacement Lens
74744	Diffuse lens for 2ft Vapor Tight
74538	Diffuse lens for 4ft Vapor Tight



# Garage

Ideal replacement for traditional HID luminaires.

SYLVANIA IP66 rated Garage luminaires are energy saving, environmentally preferable LED alternatives to traditional HID luminaires and are offered in 4000K and 5000K color temperatures with luminous efficacy up to 123 LPW. All luminaires are 0-10V dimmable down to 12% with optional sensors. They deliver a Type V Garage distribution allowing the luminaires to be strategically spaced, saving on installation and energy costs. They come with a 5-year warranty.

### Recommended applications

- High ceiling canopies
- Mid bay general lighting
- Parking garages



### Product overview

- IP66 rated for use in applications requiring a wash down or in a wet environment
- Hanging cable included for hands free wiring allowing for easy installation
- Energy savings of up to 78% over traditional HID luminaires
- Controls ready with 0-10V dimming and optional sensors for additional energy savings
- Rated life  $\geq 125,000$  hours ( $L_{70}$ )
- Instant on/instant restrike
- Wide operating temperature  $-40^{\circ}\text{F}$  to  $+104^{\circ}\text{F}$



### Savings in energy and costs over the LED lifetime per fixture\* LED vs. Traditional

	Energy consumption	Costs
Metal Halide 175W equivalent - 210W	26,250 kWh	\$3,556
SYLVANIA LED Garage - 55W	6,875 kWh	\$756
<b>SAVINGS</b>	<b>74%</b>	<b>\$2,799</b>

\*Energy costs based on \$0.11/kWh.

Traditional costs include energy cost, cost to replace lamps and ballast over the LED product life. LED cost does not include cost of the luminaire.

Energy savings are based on High Bay housing with refractor.

**Canopy**

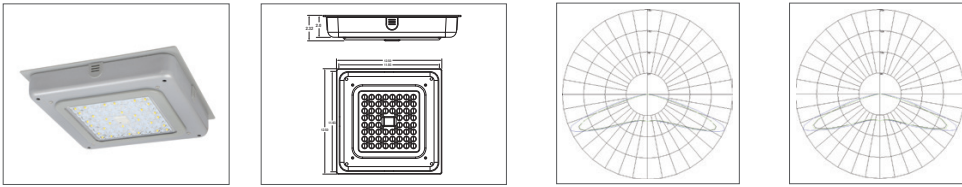

**Ordering Information**

Item Number	Product Description	Power (W)	Input Voltage	Dimming	Replacement for up to	Total Fixture Lumens	LPW*	Rated Life L <sub>70</sub> (hours)	CCT	CRI
74501	Garage 35W 4000K	35W	120-277V	0-10V	150W MH/HPS	4200	123	≥125,000	4000K	>70
74505	Garage 35W 4000K, Sensor	35W	120-277V	0-10V	150W MH/HPS	4200	123	≥125,000	4000K	>70
74502	Garage 35W 5000K	35W	120-277V	0-10V	150W MH/HPS	4200	119	≥125,000	5000K	>70
74506	Garage 35W 5000K, Sensor	35W	120-277V	0-10V	150W MH/HPS	4200	119	≥125,000	5000K	>70
74503	Garage 55W 4000K	55W	120-277V	0-10V	175W MH/150W HPS	6200	119	≥125,000	4000K	>70
74507	Garage 55W 4000K, Sensor	55W	120-277V	0-10V	175W MH/150W HPS	6200	119	≥125,000	4000K	>70
74504	Garage 55W 5000K	55W	120-277V	0-10V	175W MH/150W HPS	6200	118	≥125,000	5000K	>70
74508	Garage 55W 5000K, Sensor	55W	120-277V	0-10V	175W MH/150W HPS	6200	118	≥125,000	5000K	>70

\*LPW per LM79 Report

**Accessories and Replacement Parts**

Item Number	Product Description
74921	Polycarbonate Glare Shield
74745	16" Mounting Plate, Silver Finish
74550	Wire through connector (Set of 1)
74551	Wire through connector (Set of 2)
71758	Sensor Remote

**Garage with Glare Shield and Connectors**

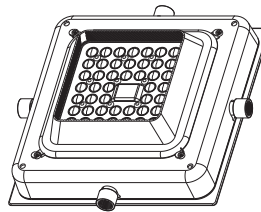

**Wire Through Connector**

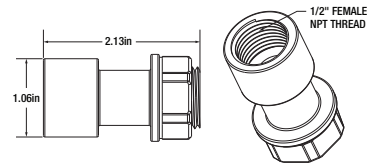

**16 Inch Mounting Plate**

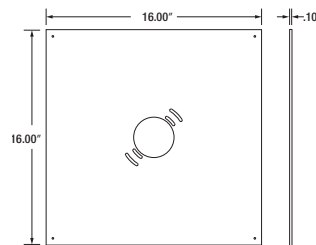



# Canopy

Ideal replacement for traditional HID luminaires.

SYLVANIA Canopy luminaires are energy saving, environmentally preferable LED alternatives to traditional HID luminaires and are offered in two wattages and lumen packages with 4000K and 5000K color temperature options and luminous efficacy up to 117 LPW. All luminaires are 0-10V dimmable down to 12%. The luminaires are constructed with one-piece cast aluminum alloy housing with powder coated paint finish and acrylic (PMMA) lens delivering a Type V distribution. They come with a 5-year warranty.

### Recommended applications

- Canopy and entryway
- Parking garages
- Stairwells



### Product overview

- Extremely durable, low profile luminaire (<2.7")
- Hanging cable included for hands free wiring allowing for easy surface or pendant installations
- Energy savings of up to 78%
- Controls ready with 0-10V dimming for additional energy savings
- Rated life  $\geq 125,000$  hours ( $L_{70}$ )
- Instant on/instant restrike
- Wet location rated
- Wide operating temperature range -40°F to +104°F



\*For more details about which products are DLC Standard or DLC Premium, please visit pages 34-37.

### Savings in energy and costs over the LED lifetime per fixture\*\* LED vs. Traditional

	Energy consumption	Costs
Metal Halide 175W equivalent - 210W	26,250 kWh	\$3,556
SYLVANIA LED Canopy - 55W	6,875 kWh	\$756
<b>SAVINGS</b>	<b>74%</b>	<b>\$2,800</b>

\*\*Energy costs based on \$0.11/kWh.

Traditional costs include energy cost, cost to replace lamps and ballast over the LED product life. LED cost does not include cost of the luminaire.



**Canopy**

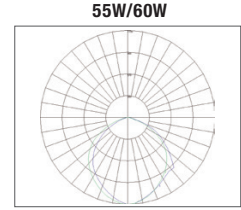
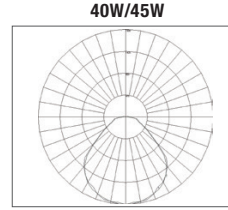
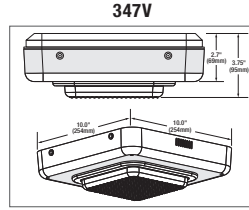
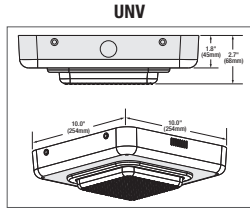

**Ordering Information (120-277V)**

Item Number	Product Description	Power (W)	Input Voltage	Dimming	Replacement for up to	Total Fixture Lumens	LPW*	Rated Life L <sub>70</sub> (hours)	CCT	CRI	Distribution
74171	Canopy UNV 40W 4000K	40W	120-277	0-10V	150W MH/HPS	4800	115	≥125,000	4000K	>70	Type V
74173	Canopy UNV 40W 5000K	40W	120-277	0-10V	150W MH/HPS	4900	117	≥125,000	5000K	>70	Type V
74172	Canopy UNV 55W 4000K	55W	120-277	0-10V	150W MH/HPS	6000	105	≥125,000	4000K	>70	Type V
74174	Canopy UNV 55W 5000K	55W	120-277	0-10V	150W MH/HPS	6200	108	≥125,000	5000K	>70	Type V

\*LPW per LM79 Report

**Ordering Information (347V)**

Item Number	Product Description	Power (W)	Input Voltage	Dimming	Replacement for up to	Total Fixture Lumens	LPW*	Rated Life L <sub>70</sub> (hours)	CCT	CRI	Distribution
74273	Canopy 347V 45W 4000K	45W	347	0-10V	150W MH/HPS	4800	100	≥125,000	4000K	>70	Type V
74275	Canopy 347V 45W 5000K	45W	347	0-10V	150W MH/HPS	4900	102	≥125,000	5000K	>70	Type V
74274	Canopy 347V 60W 4000K	60W	347	0-10V	150W MH/HPS	6000	95	≥125,000	4000K	>70	Type V
74276	Canopy 347V 60W 5000K	60W	347	0-10V	150W MH/HPS	6200	98	≥125,000	5000K	>70	Type V

\*LPW per LM79 Report

**Accessories and Replacement Parts**

Item Number	Product Description
74446	12.5" Mounting Plate, White Finish
74447	16" Mounting Plate, White Finish

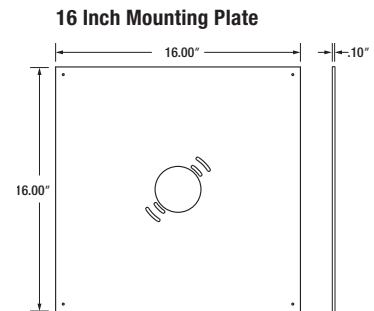
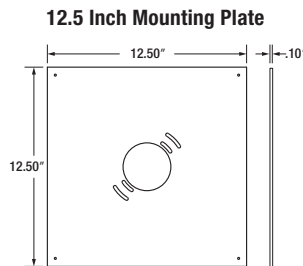



# Slim Floodlight

Ideal replacement for traditional HID luminaires.

SYLVANIA Slim Floodlight luminaires are energy saving, environmentally preferable LED alternatives to traditional HID luminaires and are offered in three wattages and lumen packages with 3000K, 4000K and 5000K color temperature options and luminous efficacy up to 121 LPW. They are designed with a compact lightweight housing, wide distribution and IP66 rating allowing the luminaire to be incorporated into almost any outdoor flood lighting application. They come with a 5-year warranty.

### Recommended applications

- Building facade and walkways
- Landscape and wall wash
- Sign and general lighting



**Product overview**

- Extremely slim lightweight housing (1.6")
- IP66 Rated for use in applications in a wet environment
- Wide flood distribution
- 1/2" NPS for mounting to junction box
- Energy savings of up to 87%
- Rated life  $\geq$ 150,000 hours (L<sub>70</sub>)
- Instant on/instant restrike
- Wide operating temperature range -40°F to +104°F



\*For more details about which products are DLC Standard or DLC Premium, please visit pages 34-37.

## Savings in energy and costs over the LED lifetime per fixture\*\* LED vs. Traditional

	Energy consumption	Costs
Metal Halide 175W equivalent - 210W	31,500 kWh	\$4,313
SYLVANIA LED Slim Floodlight - 50W	7,500 kWh	\$825
<b>SAVINGS</b>	<b>76%</b>	<b>\$3,488</b>

\*\*Energy costs based on \$0.11/kWh.

Traditional costs include energy cost, cost to replace lamps and ballast over the LED product life. LED cost does not include cost of the luminaire.

**Slim Floodlight**

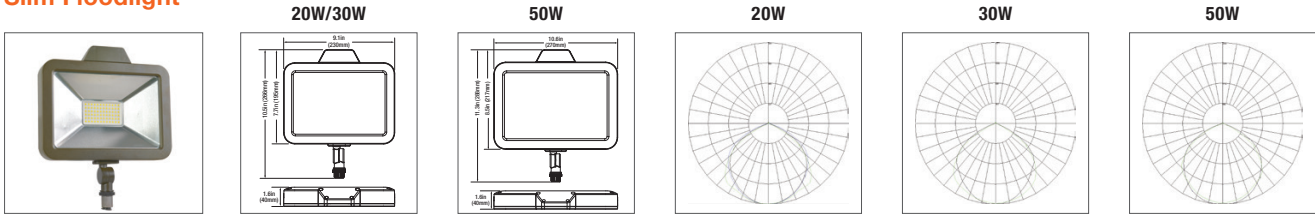

**Ordering Information (120-277V)**

Item Number	Product Description	Power (W)	Input Voltage	Replacement for up to	Total Fixture Lumens	LPW*	Rated Life L <sub>70</sub> (hours)	CCT	CRI	Distribution
74906	Slim Floodlight UNV 20W 3000K	20W	120-277V	70W MH/HPS	2000	103	≥150,000	3000K	>80	Wide
74907	Slim Floodlight UNV 20W 4000K	20W	120-277V	70W MH/HPS	2200	111	≥150,000	4000K	>80	Wide
74908	Slim Floodlight UNV 30W 4000K	30W	120-277V	100W MH/HPS	3400	110	≥150,000	4000K	>80	Wide
74909	Slim Floodlight UNV 30W 5000K	30W	120-277V	100W MH/HPS	3500	114	≥150,000	5000K	>80	Wide
74910	Slim Floodlight UNV 50W 4000K	50W	120-277V	175W MH/HPS	6100	119	≥150,000	4000K	>80	Wide
74911	Slim Floodlight UNV 50W 5000K	50W	120-277V	175W MH/HPS	6300	121	≥150,000	5000K	>80	Wide

\*LPW per LM79 Report



# Slim Wall Pack

Ideal replacement for traditional HID and incandescent luminaires.



SYLVANIA Slim Wall Pack luminaires are energy saving, environmentally preferable LED alternatives to traditional HID luminaires. They are offered in four wattages and lumen packages with 4000K and 5000K color temperature options and luminous efficacy up to 121 LPW. The luminaires are available with an optional photocell and are constructed with two-piece cast aluminum alloy housing with powder coated paint finish and glass lens. They can be used as flood lights with mounting accessories† and come with a 5 year warranty.

### Recommended applications

- Building exteriors
- Outdoor walkways and corridors
- Stairwells

†accessories sold separately

### Product overview

- Includes level on the back plate for even installation
- Aesthetically pleasing, slim design
- Energy savings of up to 87%
- Optional photocell for additional energy savings
- Rated life  $\geq 125,000$  hours ( $L_{70}$ )
- Cutoff distribution minimizes light pollution
- Instant on/instant restrike
- Wet location rated
- Wide operating temperature range  $-40^{\circ}\text{F}$  to  $+104^{\circ}\text{F}$



\*For more details about which products are DLC Standard or DLC Premium, please visit pages 34-37.

## Savings in energy and costs over the LED lifetime per fixture\*\* LED vs. Traditional

	Energy consumption	Costs
Metal Halide 150W equivalent - 188W	23,500 kWh	\$3,129
SYLVANIA LED Slim Wall Pack - 60W	7,500 kWh	\$825
<b>SAVINGS</b>	<b>68%</b>	<b>\$2,304</b>

\*\*Energy costs based on \$0.11/kWh.

Traditional costs include energy cost, cost to replace lamps and ballast over the LED product life. LED cost does not include cost of the luminaire.

Product image includes accessories that are sold separately.

**Slim Wall Pack**

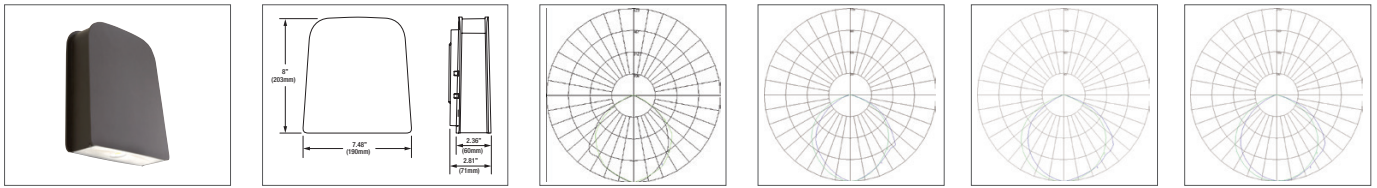

**Ordering Information (120-277V)**

Item Number	Product Description	Power (W)	Input Voltage	Replacement for up to	Total Fixture Lumens	LPW*	Rated Life L <sub>70</sub> (hours)	CRI	CCT	Distribution	BUG Rating
74340	Slim Wall Pack 1A UNV 13W 4000K	13W	120-277V	100W INC	1400	113	≥150,000	4000K	>70	Cutoff	B1-U0-G1
74341	Slim Wall Pack 1A UNV 13W 5000K	13W	120-277V	100W INC	1400	113	≥150,000	5000K	>70	Cutoff	B1-U0-G1
74192	Slim Wall Pack 1A UNV 30W 4000K	30W	120-277V	70W HPS	2800	92	≥125,000	4000K	>70	Cutoff	B1-U0-G1
74195	Slim Wall Pack 1A UNV 30W 5000K	30W	120-277V	70W HPS	2800	84	≥125,000	5000K	>70	Cutoff	B1-U0-G1
74193	Slim Wall Pack 1A UNV 40W 4000K	40W	120-277V	100W MH/HPS	4100	99	≥125,000	4000K	>70	Cutoff	B2-U0-G1
74196	Slim Wall Pack 1A UNV 40W 5000K	40W	120-277V	100W MH/HPS	3900	98	≥125,000	5000K	>70	Cutoff	B2-U0-G1
74194	Slim Wall Pack 1A UNV 60W 4000K	60W	120-277V	175W MH	5500	94	≥125,000	4000K	>70	Cutoff	B2-U0-G1
74197	Slim Wall Pack 1A UNV 60W 5000K	60W	120-277V	175W MH	5100	83	≥125,000	5000K	>70	Cutoff	B2-U0-G1
74381	Slim Wall Pack 2A UNV 30W 5000K	30W	120-277V	70W HPS	3300	112	≥125,000	5000K	>70	Cutoff	B1-U0-G1
74380	Slim Wall Pack 2A UNV 60W 4000K	60W	120-277V	175W MH	7000	117	≥125,000	4000K	>70	Cutoff	B2-U0-G1
74382	Slim Wall Pack 2A UNV 60W 5000K	60W	120-277V	175W MH	7200	121	≥125,000	5000K	>70	Cutoff	B2-U0-G1

\*LPW per LM79 Report

**Ordering Information (120V Photocell)**

Item Number	Product Description	Power (W)	Input Voltage	Replacement for up to	Total Fixture Lumens	LPW*	Rated Life L <sub>70</sub> (hours)	CRI	CCT	Distribution	BUG Rating
74342	Slim Wall Pack 1A 120V 13W 4000K, Photocell	13W	120V	100W INC	1400	113	≥150,000	4000K	>70	Cutoff	B1-U0-G1
74343	Slim Wall Pack 1A 120V 13W 5000K, Photocell	13W	120V	100W INC	1400	113	≥150,000	5000K	>70	Cutoff	B1-U0-G1
74204	Slim Wall Pack 1A 120V 30W 4000K, Photocell	30W	120V	70W HPS	2800	92	≥125,000	4000K	>70	Cutoff	B1-U0-G1
74207	Slim Wall Pack 1A 120V 30W 5000K, Photocell	30W	120V	70W HPS	2800	84	≥125,000	5000K	>70	Cutoff	B1-U0-G1
74205	Slim Wall Pack 1A 120V 40W 4000K, Photocell	40W	120V	100W MH/HPS	4100	99	≥125,000	4000K	>70	Cutoff	B2-U0-G1
74208	Slim Wall Pack 1A 120V 40W 5000K, Photocell	40W	120V	100W MH/HPS	3900	98	≥125,000	5000K	>70	Cutoff	B2-U0-G1
74206	Slim Wall Pack 1A 120V 60W 4000K, Photocell	60W	120V	175W MH	5500	94	≥125,000	4000K	>70	Cutoff	B2-U0-G1
74209	Slim Wall Pack 1A 120V 60W 5000K, Photocell	60W	120V	175W MH	5100	83	≥125,000	5000K	>70	Cutoff	B2-U0-G1
74384	Slim Wall Pack 2A 120V 30W 5000K, Photocell	30W	120V	70W HPS	3300	112	≥125,000	5000K	>70	Cutoff	B1-U0-G1
74383	Slim Wall Pack 2A 120V 60W 4000K, Photocell	60W	120V	175W MH	7000	117	≥125,000	4000K	>70	Cutoff	B2-U0-G1
74385	Slim Wall Pack 2A 120V 60W 5000K, Photocell	60W	120V	175W MH	7200	121	≥125,000	5000K	>70	Cutoff	B2-U0-G1

\*LPW per LM79 Report

**Ordering Information (347V)**

Item Number	Product Description	Power (W)	Input Voltage	Replacement for	Total Fixture Lumens	LPW*	Rated Life L <sub>70</sub> (hours)	CCT	CRI	BUG Rating
72966	Slim Wall Pack 30W 5000K	30W	347V	50-70W HPS	3400	109	≥125,000	5000K	>70	B1-U0-G1
72992	Slim Wall Pack 40W 5000K	40W	347V	70-100W HPS or MH	4300	104	≥125,000	5000K	>70	B1-U0-G1

\*LPW per LM79 Report

**Accessories and Replacement Parts**

Item Number	Product Description
74392	Junction Box, Bronze Finish
74393	Junction Box Trunnion Mount, Bronze Finish
74394	Junction Box Knuckle Mount, Bronze Finish

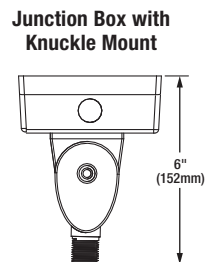
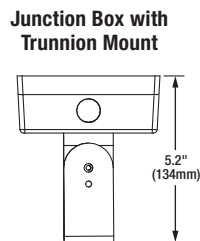
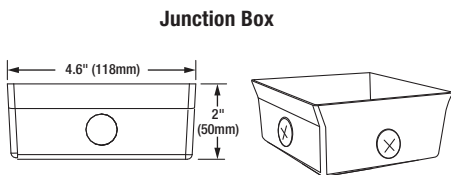



# Wall Pack Cutoff

Ideal replacement for traditional HID luminaires.

SYLVANIA Wall Pack Cutoff luminaires are energy saving, environmentally preferable LED alternatives to traditional HID luminaires. They are offered in multiple wattages and lumen packages with 4000K and 5000K color temperature options and luminous efficacy up to 135 LPW. Luminaires are available with optional photocells and are constructed with two-piece cast aluminum alloy housing with powder coated paint finish and glass lens. They come with a 5-year warranty.

### Recommended applications

- Building exteriors
- Outdoor walkways and corridors
- Stairwells



### Product overview

- Hinged for hands free wiring allowing for easy installation
- Energy savings of up to 76%
- Optional photocell for additional energy savings
- Rated life  $\geq 150,000$  hours ( $L_{70}$ ) ( $\geq 50,000$  hours for emergency versions)
- Cutoff distribution minimizes light pollution
- Instant on/instant restrike
- Wet location rated
- Wide operating temperature range  $-40^{\circ}\text{F}$  to  $+104^{\circ}\text{F}$   
EM:  $+32^{\circ}\text{F}$  to  $+104^{\circ}\text{F}$



\*For more details about which products are DLC Standard or DLC Premium, please visit pages 34-37.

### Savings in energy and costs over the LED lifetime per fixture\*\* LED vs. Traditional

	Energy consumption	Costs
Metal Halide 250W equivalent - 290W	43,500 kWh	\$5,454
SYLVANIA LED Wall Pack Cutoff - 75W	11,250 kWh	\$1,238
<b>SAVINGS</b>	<b>74%</b>	<b>\$4,216</b>

\*\*Energy costs based on \$0.11/kWh.

Traditional costs include energy cost, cost to replace lamps and ballast over the LED product life. LED cost does not include cost of the luminaire.

Wall Pack Cutoff

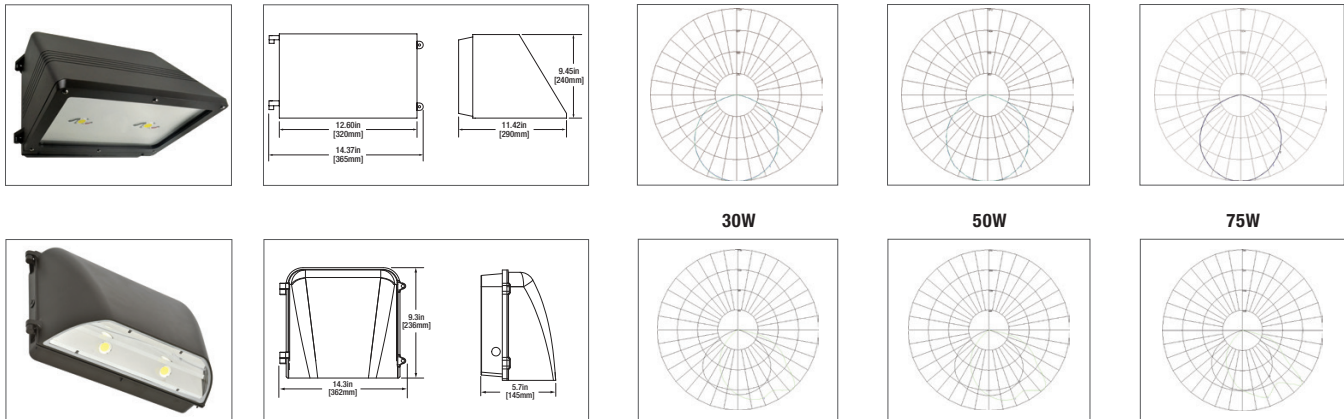

Ordering Information (120-277V)

Item Number	Product Description	Power (W)	Input Voltage	Replacement for up to	Total Fixture Lumens	LPW*	Rated Life L <sub>70</sub> (hours)	CCT	CRI	BUG Rating
74186	Wall Pack Cutoff 1C 36W 4000K	36W	120-277V	100W MH/HPS	3300	92	≥150,000	4000K	>70	B1-U0-G1
74210	Wall Pack Cutoff 1C 36W 4000K, Photocell	36W	120-277V	100W MH/HPS	3300	92	≥150,000	4000K	>70	B1-U0-G1
74189	Wall Pack Cutoff 1C 36W 5000K	36W	120-277V	100W MH/HPS	2900	82	≥150,000	5000K	>70	B1-U0-G1
74213	Wall Pack Cutoff 1C 36W 5000K, Photocell	36W	120-277V	100W MH/HPS	2900	82	≥150,000	5000K	>70	B1-U0-G1
74187	Wall Pack Cutoff 1C 50W 4000K	50W	120-277V	175W MH/HPS	5200	107	≥150,000	4000K	>70	B2-U0-G1
74211	Wall Pack Cutoff 1C 50W 4000K, Photocell	50W	120-277V	175W MH/HPS	5200	107	≥150,000	4000K	>70	B2-U0-G1
74497	Wall Pack Cutoff 1C 50W 4000K, Emergency (MTO)	50W	120-277V	175W MH/HPS	5200	107	≥50,000	4000K	>70	B2-U0-G1
74190	Wall Pack Cutoff 1C 50W 5000K	50W	120-277V	175W MH/HPS	5000	102	≥150,000	5000K	>70	B2-U0-G1
74214	Wall Pack Cutoff 1C 50W 5000K, Photocell	50W	120-277V	175W MH/HPS	5000	102	≥150,000	5000K	>70	B2-U0-G1
74498	Wall Pack Cutoff 1C 50W 5000K, Emergency (MTO)	50W	120-277V	175W MH/HPS	5000	102	≥50,000	5000K	>70	B2-U0-G1
74212	Wall Pack Cutoff 1C 75W 4000K, Photocell	75W	120-277V	250W MH/HPS	6600	91	≥150,000	4000K	>70	B2-U0-G1
74191	Wall Pack Cutoff 1C 75W 5000K	75W	120-277V	250W MH/HPS	6400	88	≥150,000	5000K	>70	B2-U0-G1
74215	Wall Pack Cutoff 1C 75W 5000K, Photocell	75W	120-277V	250W MH/HPS	6400	88	≥150,000	5000K	>70	B2-U0-G1
74912	Wall Pack Cutoff 2C 30W 4000K	30W	120-277V	100W MH/HPS	3800	135	≥150,000	4000K	>70	B2-U1-G1
74915	Wall Pack Cutoff 2C 30W 5000K	30W	120-277V	100W MH/HPS	3800	135	≥150,000	5000K	>70	B2-U1-G1
74913	Wall Pack Cutoff 2C 50W 4000K	50W	120-277V	175W MH/HPS	6200	126	≥150,000	4000K	>70	B2-U1-G2
74916	Wall Pack Cutoff 2C 50W 5000K	50W	120-277V	175W MH/HPS	6300	128	≥150,000	5000K	>70	B2-U1-G2
74914	Wall Pack Cutoff 2C 75W 4000K	75W	120-277V	250W MH/HPS	9000	120	≥150,000	4000K	>70	B3-U1-G2
74917	Wall Pack Cutoff 2C 75W 5000K	75W	120-277V	250W MH/HPS	9100	121	≥150,000	5000K	>70	B3-U1-G2

\*LPW per LM79 Report (MTO) = Made to Order

Ordering Information (347V)

Item Number	Product Description	Power (W)	Input Voltage	Replacement for up to	Total Fixture Lumens	LPW*	Rated Life L <sub>70</sub> (hours)	CCT	CRI	BUG Rating
72993	Wall Pack Cutoff 1C 40W 5000K	40W	347V	100W MH/HPS	4500	107	≥150,000	5000K	>70	B1-U0-G1
72994	Wall Pack Cutoff 1C 55W 5000K	55W	347V	175W MH/HPS	5500	101	≥150,000	5000K	>70	B2-U0-G1
72995	Wall Pack Cutoff 1C 80W 5000K	80W	347V	250W MH/HPS	8900	113	≥150,000	5000K	>70	B2-U0-G1

\*LPW per LM79 Report

Accessories and Replacement Parts

Item Number	Product Description
74396	Replacement Glass Lens with Frame



# Wall Pack Non-Cutoff



Ideal replacement for traditional HID luminaires.

SYLVANIA Wall Pack Non-Cutoff luminaires are energy saving, environmentally preferable LED alternatives to traditional HID luminaires. They are offered in multiple wattages and lumen packages with 4000K and 5000K color temperature options and luminous efficacy up to 125 LPW. Luminaires are available with optional photocells and are constructed with two-piece cast aluminum alloy housing with powder coated paint finish and borosilicate glass lens delivering a non-cutoff distribution. They come with a 5-year warranty.

### Recommended applications

- Building exteriors
- Outdoor walkways and corridors
- Stairwells

### Product overview

- Hinged for hands free wiring allowing for easy installation
- Energy savings of up to 77% over traditional HID luminaires
- Optional photocell for additional energy savings
- Rated life  $\geq 150,000$  hours ( $L_{70}$ ) ( $\geq 50,000$  hours for emergency versions)
- Non-Cutoff distribution provides superior vertical and downward illumination
- Instant on/instant restrike
- Wet location rated
- Wide operating temperature range  $-40^{\circ}\text{F}$  to  $+104^{\circ}\text{F}$   
EM:  $+32^{\circ}\text{F}$  to  $+104^{\circ}\text{F}$



\*For more details about which products are DLC Standard or DLC Premium, please visit pages 34-37.

### Savings in energy and costs over the LED lifetime per fixture\*\* LED vs. Traditional

	Energy consumption	Costs
High Pressure Sodium 250W equivalent - 295W	44,250 kWh	\$5,359
SYLVANIA LED Wall Pack Non-Cutoff - 75W	11,250 kWh	\$1,238
<b>SAVINGS</b>	<b>75%</b>	<b>\$4,121</b>

\*\*Energy costs based on \$0.11/kWh.

Traditional costs include energy cost, cost to replace lamps and ballast over the LED product life. LED cost does not include cost of the luminaire.



Wall Pack Non-Cutoff

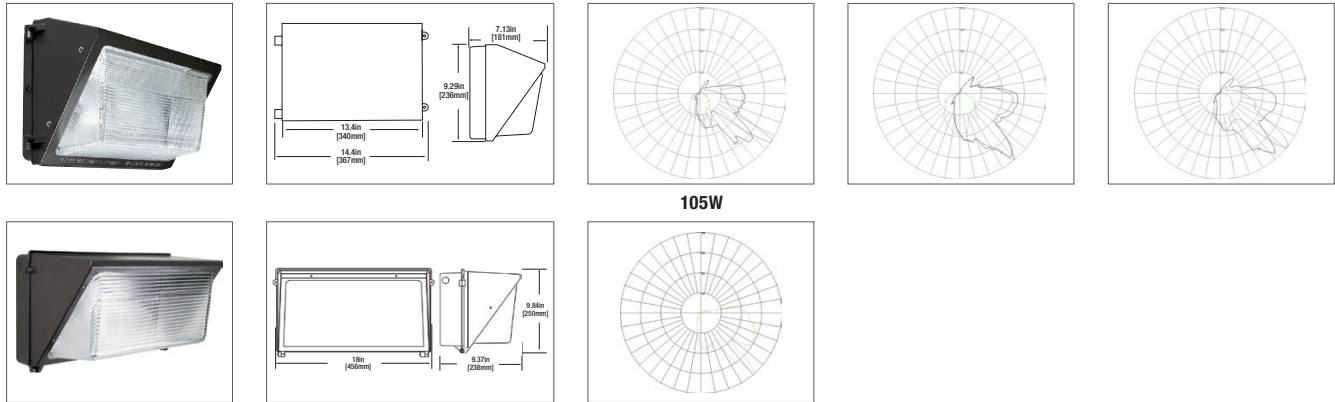

Ordering Information (120-277V)

Item Number	Product Description	Power (W)	Input Voltage	Replacement for up to	Total Fixture Lumens	LPW*	Rated Life L <sub>70</sub> (hours)	CCT	CRI	BUG Rating
74216	Wall Pack Non-Cutoff 1N UNV 36W 4000K, Photocell	36W	120-277V	100W MH/HPS	3,500	96	≥150,000	4000K	>70	B1-U4-G3
74201	Wall Pack Non-Cutoff 1N UNV 36W 5000K	36W	120-277V	100W MH/HPS	3,300	95	≥150,000	5000K	>70	B1-U3-G3
74219	Wall Pack Non-Cutoff 1N UNV 36W 5000K, Photocell	36W	120-277V	100W MH/HPS	3,300	95	≥150,000	5000K	>70	B1-U3-G3
74217	Wall Pack Non-Cutoff 1N UNV 50W 4000K, Photocell	50W	120-277V	175W MH/HPS	5,000	104	≥150,000	4000K	>70	B1-U4-G3
74499	Wall Pack Non-Cutoff 1N UNV 50W 4000K, Emergency (MTO)	50W	120-277V	175W MH/HPS	5,000	104	≥50,000	4000K	>70	B1-U4-G3
74202	Wall Pack Non-Cutoff 1N UNV 50W 5000K	50W	120-277V	175W MH/HPS	5,300	108	≥150,000	5000K	>70	B1-U4-G3
74220	Wall Pack Non-Cutoff 1N UNV 50W 5000K, Photocell	50W	120-277V	175W MH/HPS	5,300	108	≥150,000	5000K	>70	B1-U4-G3
74500	Wall Pack Non-Cutoff 1N UNV 50W 5000K, Emergency (MTO)	50W	120-277V	175W MH/HPS	5,300	108	≥50,000	5000K	>70	B1-U4-G3
74218	Wall Pack Non-Cutoff 1N UNV 75W 4000K, Photocell	75W	120-277V	250W MH/HPS	8,600	115	≥150,000	4000K	>70	B1-U5-G5
74203	Wall Pack Non-Cutoff 1N UNV 75W 5000K	75W	120-277V	250W MH/HPS	8,600	115	≥150,000	5000K	>70	B1-U5-G5
74221	Wall Pack Non-Cutoff 1N UNV 75W 5000K, Photocell	75W	120-277V	250W MH/HPS	8,600	115	≥150,000	5000K	>70	B1-U5-G5
74386	Wall Pack Non-Cutoff 2N UNV 30W 4000K	30W	120-277V	100W MH/HPS	3,400	122	≥150,000	4000K	>70	B1-U4-G3
74387	Wall Pack Non-Cutoff 2N UNV 30W 4000K, Photocell	30W	120-277V	100W MH/HPS	3,400	122	≥150,000	4000K	>70	B1-U4-G3
74482	Wall Pack Non-Cutoff 2N UNV 30W 5000K	30W	120-277V	100W MH/HPS	3,500	125	≥150,000	5000K	>70	B1-U3-G3
74483	Wall Pack Non-Cutoff 2N UNV 30W 5000K, Photocell	30W	120-277V	100W MH/HPS	3,500	125	≥150,000	5000K	>70	B1-U3-G3
74485	Wall Pack Non-Cutoff 2N UNV 50W 4000K	50W	120-277V	175W MH/HPS	5,500	113	≥150,000	4000K	>70	B1-U4-G3
74487	Wall Pack Non-Cutoff 2N UNV 50W 4000K, Photocell	50W	120-277V	175W MH/HPS	5,500	113	≥150,000	4000K	>70	B1-U4-G3
74486	Wall Pack Non-Cutoff 2N UNV 50W 5000K	50W	120-277V	175W MH/HPS	5,600	116	≥150,000	5000K	>70	B1-U4-G3
74488	Wall Pack Non-Cutoff 2N UNV 50W 5000K, Photocell	50W	120-277V	175W MH/HPS	5,600	116	≥150,000	5000K	>70	B1-U4-G3
74489	Wall Pack Non-Cutoff 2N UNV 75W 4000K	75W	120-277V	250W MH/HPS	8,900	118	≥150,000	4000K	>70	B1-U5-G5
74491	Wall Pack Non-Cutoff 2N UNV 75W 4000K, Photocell	75W	120-277V	250W MH/HPS	8,900	118	≥150,000	4000K	>70	B1-U5-G5
74490	Wall Pack Non-Cutoff 2N UNV 75W 5000K	75W	120-277V	250W MH/HPS	9,200	121	≥150,000	5000K	>70	B1-U5-G5
74492	Wall Pack Non-Cutoff 2N UNV 75W 5000K, Photocell	75W	120-277V	250W MH/HPS	9,200	121	≥150,000	5000K	>70	B1-U5-G5
74528	Wall Pack Non-Cutoff 3N UNV 105W 4000K	105W	120-277V	400W MH/HPS	12,500	119	≥150,000	4000K	>70	B3-U4-G4
74529	Wall Pack Non-Cutoff 3N UNV 105W 5000K	105W	120-277V	400W MH/HPS	12,400	118	≥150,000	5000K	>70	B2-U4-G5

\*LPW per LM79 Report (MTO) = Made to Order

Ordering Information (347V)

Item Number	Product Description	Power (W)	Input Voltage	Replacement for up to	Total Fixture Lumens	LPW*	Rated Life L <sub>70</sub> (hours)	CCT	CRI	BUG Rating
72996	Wall Pack Non-Cutoff 40W 5000K	40W	347V	70-100W HPS/MH	4300	102	≥150,000	5000K	>70	B1-U4-G3
72997	Wall Pack Non-Cutoff 55W 5000K	55W	347V	150-175 HPS/MH	6300	108	≥150,000	5000K	>70	B1-U4-G4
72998	Wall Pack Non-Cutoff 80W 5000K	80W	347V	175-250W HPS/MH	9400	120	≥150,000	5000K	>70	B1-U5-G5

\*LPW per LM79 Report

Accessories and Replacement Parts

Item Number	Product Description
74390	Top Visor, Bronze Finish (30-80W)
74539	Top Visor, Bronze Finish (105W)
74391	Wire Guard (30-80W)
74540	Wire Guard (105W)
74397	Replacement Glass Lens with Frame (30-80W)
74595	Replacement Glass Lens with Frame (105W)
74445	Polycarbonate Lens with Frame (30-80W)

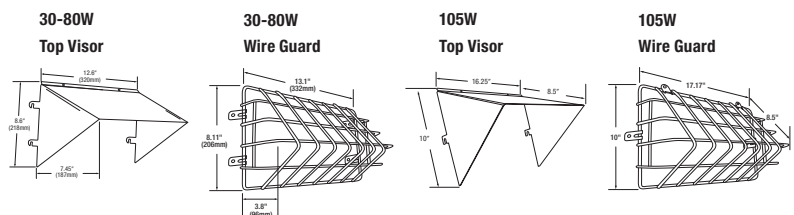

# SYLVANIA LED

## Luminaires and Retrofit Kits: Portfolio overview

The new SYLVANIA LED luminaires and retrofit kits deliver ideal solutions for a variety of applications.

This table offers a complete overview of the entire SYLVANIA luminaire portfolio. Our ordering abbreviation has been developed to be easy to read and easy to relay, simplifying the ordering process. Find which product best suits your application, then visit your local distributor today. SYLVANIA—a brand you can trust.

Item Number	Sales Part #	Watt	Dim	CRI/CCT	Dimensions	Lumens	LPW*	LED L <sub>90</sub> Lifetime (h)	Dry/ Wet/ Damp	Replaces Traditional Equivalent up to	Options**	DLC (Std. or Prem.) ENERGY STAR
74243	PANLF1A/032UNVD835/14G/WH	32	0-10	835	47.8" x 11.8" x 1.7"	3,200	102	≥50,000	Dry	2x32W T8	–	Standard
74244	PANLF1A/032UNVD840/14G/WH	32	0-10	840	47.8" x 11.8" x 1.7"	3,300	104	≥50,000	Dry	2x32W T8	–	Standard
74251	PANLF1A/032UNVD835/22G/WH	32	0-10	835	23.8" x 23.8" x 1.7"	3,500	110	≥50,000	Dry	2x32W T8	–	Standard
74252	PANLF1A/032UNVD840/22G/WH	32	0-10	840	23.8" x 23.8" x 1.7"	3,500	110	≥50,000	Dry	2x32W T8	–	Standard
74247	PANLF1A/032UNVD835/24G/WH	32	0-10	835	47.8" x 23.8" x 1.7"	3,300	104	≥50,000	Dry	2x32W T8	–	Standard
74248	PANLF1A/032UNVD840/24G/WH	32	0-10	840	47.8" x 23.8" x 1.7"	3,300	104	≥50,000	Dry	2x32W T8	–	Standard
74249	PANLF1A/040UNVD835/24G/WH	40	0-10	835	47.8" x 23.8" x 1.7"	4,200	109	≥50,000	Dry	3x32W T8	–	Standard
74250	PANLF1A/040UNVD840/24G/WH	40	0-10	840	47.8" x 23.8" x 1.7"	4,200	110	≥50,000	Dry	3x32W T8	–	Standard
74245	PANLF1A/032UNVD835/14G/WH/E	32	0-10	835	47.8" x 11.8" x 1.7"	3,200	102	≥50,000	Dry	2x32W T8	E	–
74246	PANLF1A/032UNVD840/14G/WH/E	32	0-10	840	47.8" x 11.8" x 1.7"	3,300	104	≥50,000	Dry	2x32W T8	E	–
74253	PANLF1A/032UNVD835/22G/WH/E	32	0-10	835	23.8" x 23.8" x 1.7"	3,500	110	≥50,000	Dry	2x32W T8	E	–
74254	PANLF1A/032UNVD840/22G/WH/E	32	0-10	840	23.8" x 23.8" x 1.7"	3,500	110	≥50,000	Dry	2x32W T8	E	–
74239	PANLF1A/032UNVD835/24G/WH/E	32	0-10	835	47.8" x 23.8" x 1.7"	3,300	104	≥50,000	Dry	2x32W T8	E	–
74240	PANLF1A/032UNVD840/24G/WH/E	32	0-10	840	47.8" x 23.8" x 1.7"	3,300	104	≥50,000	Dry	2x32W T8	E	–
74241	PANLF1A/040UNVD835/24G/WH/E	40	0-10	835	47.8" x 23.8" x 1.7"	4,200	109	≥50,000	Dry	3x32W T8	E	–
74242	PANLF1A/040UNVD840/24G/WH/E	40	0-10	840	47.8" x 23.8" x 1.7"	4,200	110	≥50,000	Dry	3x32W T8	E	–
74352	VOLUME1A/035UNVD835/22G/WH	35	0-10	835	23.7" x 23.7" x 3.5"	3,500	107	≥100,000	Wet***	3x17W T8 / 2U31 T8	–	Standard
74353	VOLUME1A/035UNVD840/22G/WH	35	0-10	840	23.7" x 23.7" x 3.5"	3,600	113	≥100,000	Wet***	3x17W T8 / 2U31 T8	–	Standard
74441	VOLUME1A/042UNVD835/24G/WH	42	0-10	835	47.7" x 23.7" x 3.5"	4,400	103	≥100,000	Wet***	2x32W T8	–	Standard
74442	VOLUME1A/042UNVD840/24G/WH	42	0-10	840	47.7" x 23.7" x 3.5"	4,400	103	≥100,000	Wet***	2x32W T8	–	Standard
71725	VOLUME2A/025UNVD835/22G/WH	25	0-10	835	23.7" x 23.7" x 3.5"	3,200	134	≥70,000	Wet***	3x17W T8 / 2U31 T8	–	Premium
71726	VOLUME2A/025UNVD840/22G/WH	25	0-10	840	23.7" x 23.7" x 3.5"	3,300	136	≥70,000	Wet***	3x17W T8 / 2U31 T8	–	Premium
74309	VOLUME2A/035UNVD835/24G/WH	35	0-10	835	47.7" x 23.7" x 3.5"	4,600	135	≥70,000	Wet***	2x32W T8	–	Premium
74348	VOLUME2A/035UNVD840/24G/WH	35	0-10	840	47.7" x 23.7" x 3.5"	4,600	138	≥70,000	Wet***	2x32W T8	–	Premium
74354	VOLUME1A/035UNVD835/22G/WH/E	35	0-10	835	23.7" x 23.7" x 3.5"	3,500	107	≥100,000	Wet***	3x17W T8 / 2U31 T8	E	Standard
74355	VOLUME1A/035UNVD840/22G/WH/E	35	0-10	840	23.7" x 23.7" x 3.5"	3,600	113	≥100,000	Wet***	3x17W T8 / 2U31 T8	E	Standard
74443	VOLUME1A/042UNVD835/24G/WH/E	42	0-10	835	47.7" x 23.7" x 3.5"	4,400	103	≥100,000	Wet***	2x32W T8	E	Standard
74444	VOLUME1A/042UNVD840/24G/WH/E	42	0-10	840	47.7" x 23.7" x 3.5"	4,400	103	≥100,000	Wet***	2x32W T8	E	Standard
71727	VOLUME2A/025UNVD835/22G/WH/E	25	0-10	835	23.7" x 23.7" x 3.5"	3,200	134	≥70,000	Wet***	3x17W T8 / 2U31 T8	E	Premium
71728	VOLUME2A/025UNVD840/22G/WH/E	25	0-10	840	23.7" x 23.7" x 3.5"	3,300	136	≥70,000	Wet***	3x17W T8 / 2U31 T8	E	Premium
74349	VOLUME2A/035UNVD835/24G/WH/E	35	0-10	835	47.7" x 23.7" x 3.5"	4,600	135	≥70,000	Wet***	2x32W T8	E	Premium
74356	VOLUME2A/035UNVD840/24G/WH/E	35	0-10	840	47.7" x 23.7" x 3.5"	4,600	138	≥70,000	Wet***	2x32W T8	E	Premium
74265	RDORKIT1A/035UNVD835/22A/WH	35	0-10	835	22.6" x 22.8" x 3.0"	3,400	105	≥82,000	Damp	3x17W T8 / 2U31 T8	–	Standard
74266	RDORKIT1A/035UNVD840/22A/WH	35	0-10	840	22.6" x 22.8" x 3.0"	3,500	104	≥82,000	Damp	3x17W T8 / 2U31 T8	–	Standard
74256	RDORKIT1A/035UNVD835/24A/WH	35	0-10	835	46.7" x 22.8" x 3.0"	3,500	107	≥82,000	Damp	2x32W T8	–	Standard
74255	RDORKIT1A/035UNVD840/24A/WH	35	0-10	840	46.7" x 22.8" x 3.0"	3,800	111	≥82,000	Damp	2x32W T8	–	Standard
74258	RDORKIT1A/042UNVD835/24A/WH	42	0-10	835	46.7" x 22.8" x 3.0"	4,400	106	≥82,000	Damp	3x32W T8	–	Standard
74257	RDORKIT1A/042UNVD840/24A/WH	42	0-10	840	46.7" x 22.8" x 3.0"	4,400	106	≥82,000	Damp	3x32W T8	–	Standard
74267	RDORKIT1A/035UNVD835/22A/WH/E	35	0-10	835	22.6" x 22.8" x 3.0"	3,400	105	≥82,000	Damp	3x17W T8 / 2U31 T8	E	Standard
74268	RDORKIT1A/035UNVD840/22A/WH/E	35	0-10	840	22.6" x 22.8" x 3.0"	3,500	104	≥82,000	Damp	3x17W T8 / 2U31 T8	E	Standard
74259	RDORKIT1A/035UNVD835/24A/WH/E	35	0-10	835	46.7" x 22.8" x 3.0"	3,500	107	≥82,000	Damp	2x32W T8	E	Standard
74260	RDORKIT1A/035UNVD840/24A/WH/E	35	0-10	840	46.7" x 22.8" x 3.0"	3,800	111	≥82,000	Damp	2x32W T8	E	Standard
74261	RDORKIT1A/042UNVD835/24A/WH/E	42	0-10	835	46.7" x 22.8" x 3.0"	4,400	106	≥82,000	Damp	3x32W T8	E	Standard
74262	RDORKIT1A/042UNVD840/24A/WH/E	42	0-10	840	46.7" x 22.8" x 3.0"	4,400	106	≥82,000	Damp	3x32W T8	E	Standard
75460	LED/TROFF/2L/024/UNV/D/830/22/WH	24	0-10	830	20.3" x 14.8" x 1.7"	3,000	125	≥50,000	Damp	2x17W T8 / 2U31 T8	–	Standard
75461	LED/TROFF/2L/024/UNV/D/835/22/WH	24	0-10	835	20.3" x 14.8" x 1.7"	3,000	125	≥50,000	Damp	2x17W T8 / 2U31 T8	–	Standard
75462	LED/TROFF/2L/024/UNV/D/840/22/WH	24	0-10	840	20.3" x 14.8" x 1.7"	3,000	125	≥50,000	Damp	2x17W T8 / 2U31 T8	–	Standard
75463	LED/TROFF/2L/024/UNV/D/850/22/WH	24	0-10	850	20.3" x 14.8" x 1.7"	3,000	125	≥50,000	Damp	2x17W T8 / 2U31 T8	–	Standard
75431	LED/TROFF/3L/026/UNV/D/830/22/WH	26	0-10	830	20.3" x 14.8" x 1.7"	3,200	123	≥50,000	Damp	3x17W T8 / 2U31 T8	–	Standard
75432	LED/TROFF/3L/026/UNV/D/835/22/WH	26	0-10	835	20.3" x 14.8" x 1.7"	3,200	123	≥50,000	Damp	3x17W T8 / 2U31 T8	–	Standard
75433	LED/TROFF/3L/026/UNV/D/840/22/WH	26	0-10	840	20.3" x 14.8" x 1.7"	3,200	123	≥50,000	Damp	3x17W T8 / 2U31 T8	–	Standard
75434	LED/TROFF/3L/026/UNV/D/850/22/WH	26	0-10	850	20.3" x 14.8" x 1.7"	3,200	123	≥50,000	Damp	3x17W T8 / 2U31 T8	–	Standard
75276	LED/TROFF/2L/027/UNV/D/830/22/WH	27	0-10	830	20.3" x 14.8" x 1.7"	3,000	111	≥50,000	Damp	2x17W T8 / 2U31 T8	–	–
75277	LED/TROFF/2L/027/UNV/D/835/22/WH	27	0-10	835	20.3" x 14.8" x 1.7"	3,000	111	≥50,000	Damp	2x17W T8 / 2U31 T8	–	–
75278	LED/TROFF/2L/027/UNV/D/840/22/WH	27	0-10	840	20.3" x 14.8" x 1.7"	3,000	111	≥50,000	Damp	2x17W T8 / 2U31 T8	–	–
75279	LED/TROFF/2L/027/UNV/D/850/22/WH	27	0-10	850	20.3" x 14.8" x 1.7"	3,000	111	≥50,000	Damp	2x17W T8 / 2U31 T8	–	–
75427	LED/TROFF/2L/027/UNV/D/830/24/WH	27	0-10	830	43.7" x 14.8" x 1.7"	3,200	119	≥50,000	Damp	2x32W T8	–	Standard
75428	LED/TROFF/2L/027/UNV/D/835/24/WH	27	0-10	835	43.7" x 14.8" x 1.7"	3,200	119	≥50,000	Damp	2x32W T8	–	Standard
75429	LED/TROFF/2L/027/UNV/D/840/24/WH	27	0-10	840	43.7" x 14.8" x 1.7"	3,200	119	≥50,000	Damp	2x32W T8	–	Standard
75430	LED/TROFF/2L/027/UNV/D/850/24/WH	27	0-10	850	43.7" x 14.8" x 1.7"	3,200	119	≥50,000	Damp	2x32W T8	–	Standard

\*LPW per LM79 report

\*\*Options: D = Daylight/Motion, P = Photosensor, E = Emergency (MTO) = Made to Order

\*\*\*Covered ceiling mount only

Note: All luminaires and retrofit kits are UL/ETL, FCC and RoHS

Item Number	Sales Part #	Watt	Dim	CRI/CCT	Dimensions	Lumens	LPW*	LED L70 Lifetime (h)	Dry/Wet/Damp	Replaces Traditional Equivalent up to	Options**	DLC (Std. or Prm.) ENERGY STAR
75056	LEDR/TROFF/3L/029/UNV/D/830/22/WH	29	0-10	830	20.3" x 14.8" x 1.7"	3,200	110	≥50,000	Damp	3x17W T8 / 2U31 T8	–	–
75057	LEDR/TROFF/3L/029/UNV/D/835/22/WH	29	0-10	835	20.3" x 14.8" x 1.7"	3,200	110	≥50,000	Damp	3x17W T8 / 2U31 T8	–	–
75058	LEDR/TROFF/3L/029/UNV/D/840/22/WH	29	0-10	840	20.3" x 14.8" x 1.7"	3,200	110	≥50,000	Damp	3x17W T8 / 2U31 T8	–	–
75059	LEDR/TROFF/3L/029/UNV/D/850/22/WH	29	0-10	850	20.3" x 14.8" x 1.7"	3,200	110	≥50,000	Damp	3x17W T8 / 2U31 T8	–	–
75051	LEDR/TROFF/2L/029/UNV/D/830/24/WH	29	0-10	830	43.7" x 14.8" x 1.7"	3,200	110	≥50,000	Damp	2x32W T8	–	–
75052	LEDR/TROFF/2L/029/UNV/D/835/24/WH	29	0-10	835	43.7" x 14.8" x 1.7"	3,200	110	≥50,000	Damp	2x32W T8	–	–
75053	LEDR/TROFF/2L/029/UNV/D/840/24/WH	29	0-10	840	43.7" x 14.8" x 1.7"	3,200	110	≥50,000	Damp	2x32W T8	–	–
75054	LEDR/TROFF/2L/029/UNV/D/850/24/WH	29	0-10	850	43.7" x 14.8" x 1.7"	3,200	110	≥50,000	Damp	2x32W T8	–	–
75496	LEDR/TROFF/3L/040/UNV/D/830/24/WH	40	0-10	830	43.7" x 14.8" x 1.7"	4,800	120	≥50,000	Damp	3x32W T8	–	Standard
75497	LEDR/TROFF/3L/040/UNV/D/835/24/WH	40	0-10	835	43.7" x 14.8" x 1.7"	4,800	120	≥50,000	Damp	3x32W T8	–	Standard
75498	LEDR/TROFF/3L/040/UNV/D/840/24/WH	40	0-10	840	43.7" x 14.8" x 1.7"	4,800	120	≥50,000	Damp	3x32W T8	–	Standard
75499	LEDR/TROFF/3L/040/UNV/D/850/24/WH	40	0-10	850	43.7" x 14.8" x 1.7"	4,800	120	≥50,000	Damp	3x32W T8	–	Standard
75234	LEDR/TROFF/3L/044/UNV/D/830/24/WH	44	0-10	830	43.7" x 14.8" x 1.7"	4,850	110	≥50,000	Damp	3x32W T8	–	–
75235	LEDR/TROFF/3L/044/UNV/D/835/24/WH	44	0-10	835	43.7" x 14.8" x 1.7"	4,850	110	≥50,000	Damp	3x32W T8	–	–
75236	LEDR/TROFF/3L/044/UNV/D/840/24/WH	44	0-10	840	43.7" x 14.8" x 1.7"	4,850	110	≥50,000	Damp	3x32W T8	–	–
75237	LEDR/TROFF/3L/044/UNV/D/850/24/WH	44	0-10	850	43.7" x 14.8" x 1.7"	4,850	110	≥50,000	Damp	3x32W T8	–	–
74279	PNDLUM1A/120/78/OB	–	–	–	4.5" x 1.0"	–	–	–	Dry	–	–	–
74280	PNDLUM1A/120/78/BN	–	–	–	4.5" x 1.0"	–	–	–	Dry	–	–	–
74347	LEDLUMUCCONVER9IN	4.5	Phase-cut	830	9" x 2.4" x .5"	352	82	≥35,000	Damp	15W INC	–	ENERGY STAR
74346	LEDLUMUCCONVER12IN	6	Phase-cut	830	12" x 2.4" x .5"	406	71	≥35,000	Damp	25W INC	–	ENERGY STAR
74345	LEDLUMUCCONVER18IN	8	Phase-cut	830	18" x 2.4" x .5"	626	82	≥35,000	Damp	30W INC	–	ENERGY STAR
74344	LEDLUMUCCONVER24IN	10	Phase-cut	830	24" x 2.4" x .5"	756	78	≥35,000	Damp	40W INC	–	ENERGY STAR
74263	SURFACER1A/025120T827/14S/WH	25	Phase-cut	827	14.0" x 4.5"	1,500	60	≥50,000	Dry	100W INC	–	ENERGY STAR
74264	SURFACER1A/025120T840/14S/WH	25	Phase-cut	840	14.0" x 4.5"	1,600	65	≥50,000	Dry	100W INC	–	ENERGY STAR
74305	LEDFLUSHHRND11IN16DIM827WH	17.5	Phase-cut	827	11.0" x 3.6"	1,000	57	≥35,000	Dry	75W INC	–	ENERGY STAR
74306	LEDFLUSHHRND11IN16DIM840WH	17.5	Phase-cut	840	11.0" x 3.6"	1,200	68	≥35,000	Dry	75W INC	–	ENERGY STAR
72517	LEDEDELITFLUSH15INCHRNDBN	26	Phase-cut	840	15.0" x 1.5"	1,800	69	≥35,000	Damp	75W INC	–	–
71405	LEDFLUSHHRND12IN15DIM830BN	15	Phase-cut	830	12.0" x 3.5"	1,000	67	≥50,000	Dry	75W INC	–	ENERGY STAR
71406	LEDFLUSHHRND12IN15DIM840BN	15	Phase-cut	840	12.0" x 3.5"	1,000	67	≥50,000	Dry	75W INC	–	ENERGY STAR
71403	LEDFLUSHHRND10IN15DIM830BN	15	Phase-cut	830	10.0" x 3.5"	1,000	67	≥50,000	Dry	75W INC	–	ENERGY STAR
71404	LEDFLUSHHRND10IN15DIM840BN	15	Phase-cut	840	10.0" x 3.5"	1,000	67	≥50,000	Dry	75W INC	–	ENERGY STAR
74303	LEDFLUSHSQ11IN16DIM827WH	17.5	Phase-cut	827	11.0" x 11.0" x 3.3"	1,000	57	≥35,000	Dry	75W INC	–	ENERGY STAR
74304	LEDFLUSHSQ11IN16DIM840WH	17.5	Phase-cut	840	11.0" x 11.0" x 3.3"	1,200	68	≥35,000	Dry	75W INC	–	ENERGY STAR
74307	LEDFLUSHHRNDRM11IN20DIM827WH	21	Phase-cut	827	11.0" x 3.3"	1,000	47	≥35,000	Dry	75W INC	–	ENERGY STAR
74308	LEDFLUSHHRNDRM11IN20DIM840WH	21	Phase-cut	840	11.0" x 3.3"	1,200	57	≥35,000	Dry	75W INC	–	ENERGY STAR
74302	LEDFLUSHDOME11IN20DIM827BN	21	Phase-cut	827	11.0" x 4.0"	1,000	47	≥35,000	Dry	75W INC	–	ENERGY STAR
71500	LEDFLUSHDRM11IN15DIM830WH	15	Phase-cut	830	11.0" x 3.0"	1,000	67	≥50,000	Damp	75W INC	–	ENERGY STAR
71505	LEDFLUSHDRM11IN15DIM840WH	15	Phase-cut	830	11.0" x 3.0"	1,000	67	≥50,000	Damp	75W INC	–	ENERGY STAR
74234	HIBAY1A/16H5	–	–	–	16.2" x 10.4"	–	–	–	–	–	–	–
74395	HIBAY1A/20ALH5	–	–	–	20.0" x 5.6"	–	–	–	–	–	–	–
74230	HIBAY1A/100UNVD840/GR	100	0-10	840	7.0" x 13.4"	10,800	108	≥63,000	Damp	250W HPS/MH	–	Standard
74231	HIBAY1A/100UNVD850/GR	100	0-10	850	7.0" x 13.4"	10,800	108	≥63,000	Damp	250W HPS/MH	–	Standard
74232	HIBAY1A/200UNVD840/GR	200	0-10	840	8.8" x 15.2"	22,200	114	≥150,000	Damp	400W HPS/MH	–	Standard
74233	HIBAY1A/200UNVD850/GR	200	0-10	850	8.8" x 15.2"	22,500	115	≥150,000	Damp	400W HPS/MH	–	Standard
71731	HIBAY1A/300UNVD840/GR	300	0-10	840	8.9" x 17.4"	29,600	102	≥73,000	Damp	1000W HPS/MH	–	Standard
71732	HIBAY1A/300UNVD850/GR	300	0-10	850	8.9" x 17.4"	30,300	104	≥73,000	Damp	1000W HPS/MH	–	Standard
74269	HIBAY1A/100347D840/GR	100	0-10	840	7.0" x 13.4"	10,800	108	≥63,000	Damp	250W HPS/MH	–	–
74272	HIBAY1A/200347D850/GR	200	0-10	850	8.8" x 15.2"	20,600	103	≥63,000	Damp	400W HPS/MH	–	Standard
74509	HIBAY1A/100HUV840/GR	100	0-10	840	7.0" x 13.4"	10,800	108	≥150,000	Damp	250W HPS/MH	–	Standard
74510	HIBAY1A/100HUV850/GR	100	0-10	850	7.0" x 13.4"	10,800	108	≥150,000	Damp	250W HPS/MH	–	Standard
74511	HIBAY1A/200HUV840/GR	200	0-10	840	8.8" x 15.2"	23,300	123	≥150,000	Damp	400W HPS/MH	–	Standard
74512	HIBAY1A/200HUV850/GR	200	0-10	850	8.8" x 15.2"	23,100	122	≥150,000	Damp	400W HPS/MH	–	Standard
74839	LNHIBA1A/100UNVD840/A/WH	100	0-10	840	46.0" x 7.9" x 2.9"	13,000	127	≥80,000	Damp	250W HPS/MH	–	Premium
74840	LNHIBA1A/100UNVD850/A/WH	100	0-10	850	46.0" x 7.9" x 2.9"	13,000	127	≥80,000	Damp	250W HPS/MH	–	Premium
74837	LNHIBA1A/100UNVD840/W/WH	100	0-10	840	46.0" x 7.9" x 2.9"	12,900	127	≥80,000	Damp	250W HPS/MH	–	Premium
74838	LNHIBA1A/100UNVD850/W/WH	100	0-10	850	46.0" x 7.9" x 2.9"	12,900	127	≥80,000	Damp	250W HPS/MH	–	Premium
74847	LNHIBA1A/150UNVD840/A/WH (MTO)	150	0-10	840	46.0" x 7.9" x 2.9"	19,100	130	≥100,000	Damp	250W HPS/MH	–	Premium
74848	LNHIBA1A/150UNVD850/A/WH (MTO)	150	0-10	850	46.0" x 7.9" x 2.9"	19,100	130	≥100,000	Damp	250W HPS/MH	–	Premium
74845	LNHIBA1A/150UNVD840/W/WH	150	0-10	840	46.0" x 7.9" x 2.9"	19,700	133	≥100,000	Damp	250W HPS/MH	–	Premium
74846	LNHIBA1A/150UNVD850/W/WH	150	0-10	850	46.0" x 7.9" x 2.9"	19,700	133	≥100,000	Damp	250W HPS/MH	–	Premium
74831	LNHIBA1A/165UNVD840/A/WH	165	0-10	840	46.0" x 7.9" x 2.9"	18,900	117	≥80,000	Damp	320W MH	–	Standard
74832	LNHIBA1A/165UNVD850/A/WH	165	0-10	850	46.0" x 7.9" x 2.9"	18,900	117	≥80,000	Damp	320W MH	–	Standard
74829	LNHIBA1A/165UNVD840/W/WH	165	0-10	840	46.0" x 7.9" x 2.9"	18,100	112	≥80,000	Damp	320W MH	–	Standard
74830	LNHIBA1A/165UNVD850/W/WH	165	0-10	850	46.0" x 7.9" x 2.9"	18,100	112	≥80,000	Damp	320W MH	–	Standard

\*LPW per LM79 report  
 \*\*Options: D = Daylight/Motion, P = Photosensor, E = Emergency (MTO) = Made to Order  
 Note: All luminaires and retrofit kits are UL/ETL, FCC and RoHS

Item Number	Sales Part #	Watt	Dim	CRI/CCT	Dimensions	Lumens	LPW*	LED L <sub>70</sub> Lifetime (h)	Dry/Wet/Damp	Replaces Traditional Equivalent up to	Options**	DLC (Std. or Prm.) ENERGY STAR
74823	LNHIBA1A/225UNVD840/A/WH	225	0-10	840	46.0" x 11.8" x 2.9"	25,300	112	≥80,000	Damp	400W HPS/MH	–	Standard
74824	LNHIBA1A/225UNVD850/A/WH	225	0-10	850	46.0" x 11.8" x 2.9"	25,300	112	≥80,000	Damp	400W HPS/MH	–	Standard
74821	LNHIBA1A/225UNVD840/W/WH	225	0-10	840	46.0" x 11.8" x 2.9"	26,600	117	≥80,000	Damp	400W HPS/MH	–	Standard
74822	LNHIBA1A/225UNVD850/W/WH	225	0-10	850	46.0" x 11.8" x 2.9"	26,600	117	≥80,000	Damp	400W HPS/MH	–	Standard
74843	LNHIBA1A/100UNVD840/A/WH/D (MTO)	100	0-10	840	46.0" x 7.9" x 2.9"	13,000	127	≥80,000	Damp	250W HPS/MH	D	Premium
74844	LNHIBA1A/100UNVD850/A/WH/D (MTO)	100	0-10	850	46.0" x 7.9" x 2.9"	13,000	127	≥80,000	Damp	250W HPS/MH	D	Premium
74841	LNHIBA1A/100UNVD840/W/WH/D (MTO)	100	0-10	840	46.0" x 7.9" x 2.9"	12,900	127	≥80,000	Damp	250W HPS/MH	D	Premium
74842	LNHIBA1A/100UNVD850/W/WH/D (MTO)	100	0-10	850	46.0" x 7.9" x 2.9"	12,900	127	≥80,000	Damp	250W HPS/MH	D	Premium
74853	LNHIBA1A/150UNVD840/A/WH/D (MTO)	150	0-10	840	46.0" x 7.9" x 2.9"	19,100	130	≥100,000	Damp	250W HPS/MH	D	Premium
74905	LNHIBA1A/150UNVD850/A/WH/D (MTO)	150	0-10	850	46.0" x 7.9" x 2.9"	19,100	130	≥100,000	Damp	250W HPS/MH	D	Premium
74849	LNHIBA1A/150UNVD840/W/WH/D (MTO)	150	0-10	840	46.0" x 7.9" x 2.9"	19,700	133	≥100,000	Damp	250W HPS/MH	D	Premium
74850	LNHIBA1A/150UNVD850/W/WH/D (MTO)	150	0-10	850	46.0" x 7.9" x 2.9"	19,700	133	≥100,000	Damp	250W HPS/MH	D	Premium
74835	LNHIBA1A/165UNVD840/A/WH/D (MTO)	165	0-10	840	46.0" x 7.9" x 2.9"	18,900	117	≥80,000	Damp	320W MH	D	Standard
74836	LNHIBA1A/165UNVD850/A/WH/D (MTO)	165	0-10	850	46.0" x 7.9" x 2.9"	18,900	117	≥80,000	Damp	320W MH	D	Standard
74833	LNHIBA1A/165UNVD840/W/WH/D (MTO)	165	0-10	840	46.0" x 7.9" x 2.9"	18,100	112	≥80,000	Damp	320W MH	D	Standard
74834	LNHIBA1A/165UNVD850/W/WH/D (MTO)	165	0-10	850	46.0" x 7.9" x 2.9"	18,100	112	≥80,000	Damp	320W MH	D	Standard
74827	LNHIBA1A/225UNVD840/A/WH/D (MTO)	225	0-10	840	46.0" x 11.8" x 2.9"	25,300	112	≥80,000	Damp	400W HPS/MH	D	Standard
74828	LNHIBA1A/225UNVD850/A/WH/D (MTO)	225	0-10	850	46.0" x 11.8" x 2.9"	25,300	112	≥80,000	Damp	400W HPS/MH	D	Standard
74825	LNHIBA1A/225UNVD840/W/WH/D (MTO)	225	0-10	840	46.0" x 11.8" x 2.9"	26,600	117	≥80,000	Damp	400W HPS/MH	D	Standard
74826	LNHIBA1A/225UNVD850/W/WH/D (MTO)	225	0-10	850	46.0" x 11.8" x 2.9"	26,600	117	≥80,000	Damp	400W HPS/MH	D	Standard
74530	VAPOR1A/025UNVD840/24EC/GR	25	0-10	840	24.5" x 4.1" x 3.3"	3,100	135	≥122,000	IP65	2 F32T8/70W HPS	–	Premium
74531	VAPOR1A/025UNVD850/24EC/GR	25	0-10	850	24.5" x 4.1" x 3.3"	3,100	137	≥122,000	IP65	2 F32T8/70W HPS	–	Premium
74224	VAPOR1A/050UNVD840/48EC/GR/D	50	0-10	840	48.5" x 4.0" x 3.3"	5,000	102	≥68,000	IP65	F96T12/70W MH	D	–
74225	VAPOR1A/050UNVD850/48EC/GR/D	50	0-10	850	48.5" x 4.0" x 3.3"	5,000	103	≥67,000	IP65	F96T12/70W MH	D	–
74227	VAPOR1A/050UNVD850/48EC/GR/E	50	0-10	850	48.5" x 4.0" x 3.3"	5,000	103	≥66,000	IP65	F96T12/70W MH	E	–
74552	VAPOR1A/050HUV840/48EC/GR	50	0-10	840	48.5" x 4.1" x 3.3"	5,700	111	≥84,000	IP65	F96T12/70W MH	–	Standard
74553	VAPOR1A/050HUV850/48EC/GR	50	0-10	850	48.5" x 4.1" x 3.3"	5,700	111	≥84,000	IP65	F96T12/70W MH	–	Standard
74376	VAPOR1B/040UNVD840/48EC/GR	40	0-10	840	48.5" x 4.1" x 3.3"	5,300	139	≥120,000	IP65	F96T12/70W MH	–	Premium
74377	VAPOR1B/040UNVD850/48EC/GR	40	0-10	850	48.5" x 4.1" x 3.3"	5,300	137	≥120,000	IP65	F96T12/70W MH	–	Premium
74378	VAPOR1B/040UNVD840/48EC/GR/D	40	0-10	840	48.5" x 4.1" x 3.3"	5,400	140	≥120,000	IP65	F96T12/70W MH	D	Premium
74379	VAPOR1B/040UNVD850/48EC/GR/D	40	0-10	850	48.5" x 4.1" x 3.3"	5,400	137	≥120,000	IP65	F96T12/70W MH	D	Premium
74554	VAPOR1B/040UNVD840/48EC/GR/E	40	0-10	840	48.5" x 4.1" x 3.3"	5,300	139	≥120,000	IP65	F96T12/70W MH	E	Premium
74555	VAPOR1B/040UNVD850/48EC/GR/E	40	0-10	850	48.5" x 4.1" x 3.3"	5,300	137	≥120,000	IP65	F96T12/70W MH	E	Premium
74556	VAPOR1B/040UNVD840/48EC/GR/DE	40	0-10	840	48.5" x 4.1" x 3.3"	5,400	140	≥120,000	IP65	F96T12/70W MH	DE	Premium
74557	VAPOR1B/040UNVD850/48EC/GR/DE	40	0-10	850	48.5" x 4.1" x 3.3"	5,400	137	≥120,000	IP65	F96T12/70W MH	DE	Premium
74501	GARAG1A/035UNVD740/G5/SV	35	0-10	740	12.5" x 12.5" x 2.32"	4,200	123	≥125,000	IP66	150W MH	–	Premium
74502	GARAG1A/035UNVD750/G5/SV	35	0-10	750	12.5" x 12.5" x 2.32"	4,200	119	≥125,000	IP66	150W MH	–	Premium
74503	GARAG1A/055UNVD740/G5/SV	55	0-10	740	12.5" x 12.5" x 2.32"	6,200	119	≥125,000	IP66	175W MH	–	Premium
74504	GARAG1A/055UNVD750/G5/SV	55	0-10	750	12.5" x 12.5" x 2.32"	6,200	118	≥125,000	IP66	175W MH	–	Premium
74505	GARAG1A/035UNVD740/G5/SV/D	35	0-10	740	12.5" x 12.5" x 2.32"	4,200	123	≥125,000	IP66	150W MH	D	Premium
74506	GARAG1A/035UNVD750/G5/SV/D	35	0-10	750	12.5" x 12.5" x 2.32"	4,200	119	≥125,000	IP66	150W MH	D	Premium
74507	GARAG1A/055UNVD740/G5/SV/D	55	0-10	740	12.5" x 12.5" x 2.32"	6,200	119	≥125,000	IP66	175W MH	D	Premium
74508	GARAG1A/055UNVD750/G5/SV/D	55	0-10	750	12.5" x 12.5" x 2.32"	6,200	118	≥125,000	IP66	175W MH	D	Premium
74171	CANOPYA/040UNVD740/10C5/WH	40	0-10	740	10.0" x 10.0" x 2.7"	4,800	115	≥125,000	Wet	150W MH	–	Premium
74173	CANOPYA/040UNVD750/10C5/WH	40	0-10	750	10.0" x 10.0" x 2.7"	4,900	117	≥125,000	Wet	150W MH	–	Premium
74172	CANOPYA/055UNVD740/10C5/WH	55	0-10	740	10.0" x 10.0" x 2.7"	6,000	105	≥125,000	Wet	175W MH	–	Standard
74174	CANOPYA/055UNVD750/10C5/WH	55	0-10	750	10.0" x 10.0" x 2.7"	6,200	108	≥125,000	Wet	175W MH	–	Standard
74273	CANOPYA/045347D740/10C5/WH	45	0-10	740	10.0" x 10.0" x 3.8"	4,800	100	≥125,000	Wet	150W MH	–	Standard
74275	CANOPYA/045347D750/10C5/WH	45	0-10	750	10.0" x 10.0" x 3.8"	4,900	102	≥125,000	Wet	150W MH	–	Standard
74274	CANOPYA/060347D740/10C5/WH	60	0-10	740	10.0" x 10.0" x 3.8"	6,000	95	≥125,000	Wet	175W MH	–	Standard
74276	CANOPYA/060347D750/10C5/WH	60	0-10	750	10.0" x 10.0" x 3.8"	6,200	98	≥125,000	Wet	175W MH	–	Standard
74906	SLMFLD1A/020UNV830/WF/BZ	20	–	830	9.1" x 1.6" x 10.8"	2,000	103	≥150,000	IP66	70W HPS/MH	–	Standard
74907	SLMFLD1A/020UNV840/WF/BZ	20	–	840	9.1" x 1.6" x 10.8"	2,200	111	≥150,000	IP66	70W HPS/MH	–	Premium
74908	SLMFLD1A/030UNV840/WF/BZ	30	–	840	9.1" x 1.6" x 10.8"	3,400	110	≥150,000	IP66	100W HPS/MH	–	Premium
74909	SLMFLD1A/030UNV850/WF/BZ	30	–	850	9.1" x 1.6" x 10.8"	3,500	114	≥150,000	IP66	100W HPS/MH	–	Premium
74910	SLMFLD1A/050UNV840/WF/BZ	50	–	840	10.7" x 1.6" x 11.7"	6,100	119	≥150,000	IP66	175W HPS/MH	–	Premium
74911	SLMFLD1A/050UNV850/WF/BZ	50	–	850	10.7" x 1.6" x 11.7"	6,300	121	≥150,000	IP66	175W HPS/MH	–	Premium
74340	SLMWP1A/013UNV740/CO/BZ	13	–	740	7.5" x 2.8" x 8.0"	1,400	113	≥150,000	Wet	100W INC	–	Standard
74341	SLMWP1A/013UNV750/CO/BZ	13	–	750	7.5" x 2.8" x 8.0"	1,400	113	≥150,000	Wet	100W INC	–	Standard
74192	SLMWP1A/030UNV740/CO/BZ	30	–	740	7.5" x 2.8" x 8.0"	2,800	92	≥125,000	Wet	70W HPS	–	Standard
74195	SLMWP1A/030UNV750/CO/BZ	30	–	750	7.5" x 2.8" x 8.0"	2,800	84	≥125,000	Wet	70W HPS	–	–
74193	SLMWP1A/040UNV740/CO/BZ	40	–	740	7.5" x 2.8" x 8.0"	4,100	99	≥125,000	Wet	100W HPS/MH	–	Standard
74196	SLMWP1A/040UNV750/CO/BZ	40	–	750	7.5" x 2.8" x 8.0"	3,900	98	≥125,000	Wet	100W HPS/MH	–	Standard
74194	SLMWP1A/060UNV740/CO/BZ	60	–	740	7.5" x 2.8" x 8.0"	5,500	94	≥125,000	Wet	175W MH	–	Standard
74197	SLMWP1A/060UNV750/CO/BZ	60	–	750	7.5" x 2.8" x 8.0"	5,100	83	≥125,000	Wet	175W MH	–	–

\*LPW per LM79 report  
 \*\*Options: D = Daylight/Motion, P = Photosensor, E = Emergency  
 (MTO) = Made to Order  
 Note: All luminaires and retrofit kits are UL/ETL, FCC and RoHS

Item Number	Sales Part #	Watt	Dim	CRI/CCT	Dimensions	Lumens	LPW*	LED L70 Lifetime (h)	Dry/Wet/Damp	Replaces Traditional Equivalent up to	Options**	DLC (Std. or Prm.) ENERGY STAR
74342	SLMWP1A/013120740/CO/BZ/P	13	–	740	7.5" x 2.8" x 8.0"	1,400	113	≥150,000	Wet	100W INC	P	Standard
74343	SLMWP1A/013120750/CO/BZ/P	13	–	750	7.5" x 2.8" x 8.0"	1,400	113	≥150,000	Wet	100W INC	P	Standard
74204	SLMWP1A/030120740/CO/BZ/P	30	–	740	7.5" x 2.8" x 8.0"	2,800	92	≥125,000	Wet	70W HPS	P	Standard
74207	SLMWP1A/030120750/CO/BZ/P	30	–	750	7.5" x 2.8" x 8.0"	2,800	84	≥125,000	Wet	70W HPS	P	–
74205	SLMWP1A/040120740/CO/BZ/P	40	–	740	7.5" x 2.8" x 8.0"	4,100	99	≥125,000	Wet	100W HPS/MH	P	Standard
74208	SLMWP1A/040120750/CO/BZ/P	40	–	750	7.5" x 2.8" x 8.0"	3,900	98	≥125,000	Wet	100W HPS/MH	P	Standard
74206	SLMWP1A/060120740/CO/BZ/P	60	–	740	7.5" x 2.8" x 8.0"	5,500	94	≥125,000	Wet	175W MH	P	Standard
74209	SLMWP1A/060120750/CO/BZ/P	60	–	750	7.5" x 2.8" x 8.0"	5,100	83	≥125,000	Wet	175W MH	P	–
72966	SLMWP1A/030347750/CO/BZ	30	–	750	7.5" x 2.8" x 8.0"	3,400	109	≥125,000	Wet	70W HPS	–	Standard
72992	SLMWP1A/040347750/CO/BZ	40	–	750	7.5" x 2.8" x 8.0"	4,300	104	≥125,000	Wet	100W HPS/MH	–	Standard
74381	SLMWP2A/030UNV750/CO/BZ	30	–	750	7.5" x 2.8" x 8.0"	3,300	112	≥125,000	Wet	70W HPS	–	Premium
74380	SLMWP2A/060UNV740/CO/BZ	60	–	740	7.5" x 2.8" x 8.0"	7,000	117	≥125,000	Wet	175W MH	–	Premium
74382	SLMWP2A/060UNV750/CO/BZ	60	–	750	7.5" x 2.8" x 8.0"	7,200	121	≥125,000	Wet	175W MH	–	Premium
74384	SLMWP2A/030120750/CO/BZ/P	30	–	750	7.5" x 2.8" x 8.0"	3,300	112	≥125,000	Wet	70W HPS	P	Premium
74383	SLMWP2A/060120740/CO/BZ/P	60	–	740	7.5" x 2.8" x 8.0"	7,000	117	≥125,000	Wet	175W MH	P	Premium
74385	SLMWP2A/060120750/CO/BZ/P	60	–	750	7.5" x 2.8" x 8.0"	7,200	121	≥125,000	Wet	175W MH	P	Premium
74186	WALPAK1C/036UNV740/CO/BZ	36	–	740	14.4" x 11.4" x 9.5"	3,300	92	≥150,000	Wet	100W HPS/MH	–	Standard
74189	WALPAK1C/036UNV750/CO/BZ	36	–	750	14.4" x 11.4" x 9.5"	2,900	82	≥150,000	Wet	100W HPS/MH	–	–
74187	WALPAK1C/050UNV740/CO/BZ	50	–	740	14.4" x 11.4" x 9.5"	5,200	107	≥150,000	Wet	175W MH	–	Standard
74190	WALPAK1C/050UNV750/CO/BZ	50	–	750	14.4" x 11.4" x 9.5"	5,000	102	≥150,000	Wet	175W MH	–	Standard
74191	WALPAK1C/075UNV750/CO/BZ	75	–	750	14.4" x 11.4" x 9.5"	6,400	88	≥150,000	Wet	250W HPS/MH	–	–
74210	WALPAK1C/036UNV740/CO/BZ/P	36	–	740	14.4" x 11.4" x 9.5"	3,300	92	≥150,000	Wet	100W HPS/MH	P	Standard
74213	WALPAK1C/036UNV750/CO/BZ/P	36	–	750	14.4" x 11.4" x 9.5"	2,900	82	≥150,000	Wet	100W HPS/MH	P	Standard
74211	WALPAK1C/050UNV740/CO/BZ/P	50	–	740	14.4" x 11.4" x 9.5"	5,200	107	≥150,000	Wet	175W MH	P	Standard
74214	WALPAK1C/050UNV750/CO/BZ/P	50	–	750	14.4" x 11.4" x 9.5"	5,000	102	≥150,000	Wet	175W MH	P	Standard
74212	WALPAK1C/075UNV740/CO/BZ/P	75	–	740	14.4" x 11.4" x 9.5"	6,600	91	≥150,000	Wet	250W HPS/MH	P	–
74215	WALPAK1C/075UNV750/CO/BZ/P	75	–	750	14.4" x 11.4" x 9.5"	6,400	88	≥150,000	Wet	250W HPS/MH	P	–
72993	WALPAK1C/040347750/CO/BZ	40	–	750	14.4" x 11.4" x 9.5"	4,500	107	≥150,000	Wet	100W HPS/MH	–	Standard
72994	WALPAK1C/055347750/CO/BZ	55	–	750	14.4" x 11.4" x 9.5"	5,500	101	≥150,000	Wet	175W MH	–	Standard
72995	WALPAK1C/080347750/CO/BZ	80	–	750	14.4" x 11.4" x 9.5"	8,900	113	≥150,000	Wet	250W HPS/MH	–	Standard
74497	WALPAK1C/050UNV740/CO/BZ/E (MTO)	50	–	740	14.4" x 11.4" x 9.5"	5,200	107	≥50,000	Wet	175W MH	E	Standard
74498	WALPAK1C/050UNV750/CO/BZ/E (MTO)	50	–	750	14.4" x 11.4" x 9.5"	5,000	102	≥50,000	Wet	175W MH	E	Standard
74912	WALPAK2C/030UNV740/CO/BZ	30	–	840	14.3" x 5.7" x 9.3"	3,800	135	≥150,000	Wet	100W HPS/MH	–	Premium
74915	WALPAK2C/030UNV750/CO/BZ	30	–	850	14.3" x 5.7" x 9.3"	3,800	135	≥150,000	Wet	100W HPS/MH	–	Premium
74913	WALPAK2C/050UNV740/CO/BZ	50	–	840	14.3" x 5.7" x 9.3"	6,200	126	≥150,000	Wet	175W MH	–	Premium
74916	WALPAK2C/050UNV750/CO/BZ	50	–	850	14.3" x 5.7" x 9.3"	6,300	128	≥150,000	Wet	175W MH	–	Premium
74914	WALPAK2C/075UNV740/CO/BZ	75	–	840	14.3" x 5.7" x 9.3"	9,000	120	≥150,000	Wet	250W HPS/MH	–	Premium
74917	WALPAK2C/075UNV750/CO/BZ	75	–	850	14.3" x 5.7" x 9.3"	9,100	121	≥150,000	Wet	250W HPS/MH	–	Premium
74201	WALPAK1N/036UNV750/NC/BZ	36	–	750	14.4" x 7.1" x 9.3"	3,300	95	≥150,000	Wet	100W HPS/MH	–	–
74202	WALPAK1N/050UNV750/NC/BZ	50	–	750	14.4" x 7.1" x 9.3"	5,300	108	≥150,000	Wet	175W MH	–	–
74203	WALPAK1N/075UNV750/NC/BZ	75	–	750	14.4" x 7.1" x 9.3"	8,600	115	≥150,000	Wet	250W HPS/MH	–	–
74216	WALPAK1N/036UNV740/NC/BZ/P	36	–	740	14.4" x 7.1" x 9.3"	3,500	96	≥150,000	Wet	100W HPS/MH	P	–
74219	WALPAK1N/036UNV750/NC/BZ/P	36	–	750	14.4" x 7.1" x 9.3"	3,300	95	≥150,000	Wet	100W HPS/MH	P	–
74217	WALPAK1N/050UNV740/NC/BZ/P	50	–	740	14.4" x 7.1" x 9.3"	5,000	104	≥150,000	Wet	175W MH	P	–
74220	WALPAK1N/050UNV750/NC/BZ/P	50	–	750	14.4" x 7.1" x 9.3"	5,300	108	≥150,000	Wet	175W MH	P	–
74218	WALPAK1N/075UNV740/NC/BZ/P	75	–	740	14.4" x 7.1" x 9.3"	8,600	115	≥150,000	Wet	250W HPS/MH	P	–
74221	WALPAK1N/075UNV750/NC/BZ/P	75	–	750	14.4" x 7.1" x 9.3"	8,600	115	≥150,000	Wet	250W HPS/MH	P	–
72996	WALPAK1N/040347750/NC/BZ	40	–	750	14.4" x 7.1" x 9.3"	4,300	102	≥150,000	Wet	100W HPS/MH	–	–
72997	WALPAK1N/055347750/NC/BZ	55	–	750	14.4" x 7.1" x 9.3"	6,300	108	≥150,000	Wet	175W MH	–	–
72998	WALPAK1N/080347750/NC/BZ	80	–	750	14.4" x 7.1" x 9.3"	9,400	120	≥150,000	Wet	250W HPS/MH	–	Standard
74499	WALPAK1N/050UNV740/NC/BZ/E (MTO)	50	–	740	14.4" x 7.1" x 9.3"	5,000	104	≥50,000	Wet	175W MH	E	Standard
74500	WALPAK1N/050UNV750/NC/BZ/E (MTO)	50	–	750	14.4" x 7.1" x 9.3"	5,300	108	≥50,000	Wet	175W MH	E	Standard
74386	WALPAK2N/030UNV740/NC/BZ	30	–	740	14.4" x 7.1" x 9.3"	3,400	122	≥150,000	Wet	100W HPS/MH	–	Premium
74482	WALPAK2N/030UNV750/NC/BZ	30	–	750	14.4" x 7.1" x 9.3"	3,500	125	≥150,000	Wet	100W HPS/MH	–	Premium
74485	WALPAK2N/050UNV740/NC/BZ	50	–	740	14.4" x 7.1" x 9.3"	5,500	113	≥150,000	Wet	175W MH	–	Standard
74486	WALPAK2N/050UNV750/NC/BZ	50	–	750	14.4" x 7.1" x 9.3"	5,600	116	≥150,000	Wet	175W MH	–	Standard
74489	WALPAK2N/075UNV740/NC/BZ	75	–	740	14.4" x 7.1" x 9.3"	8,900	118	≥150,000	Wet	250W HPS/MH	–	Standard
74490	WALPAK2N/075UNV750/NC/BZ	75	–	750	14.4" x 7.1" x 9.3"	9,200	121	≥150,000	Wet	250W HPS/MH	–	Standard
74387	WALPAK2N/030UNV740/NC/BZ/P	30	–	740	14.4" x 7.1" x 9.3"	3,400	122	≥150,000	Wet	100W HPS/MH	P	Premium
74483	WALPAK2N/030UNV750/NC/BZ/P	30	–	750	14.4" x 7.1" x 9.3"	3,500	125	≥150,000	Wet	100W HPS/MH	P	Premium
74487	WALPAK2N/050UNV740/NC/BZ/P	50	–	740	14.4" x 7.1" x 9.3"	5,500	113	≥150,000	Wet	175W MH	P	Standard
74488	WALPAK2N/050UNV750/NC/BZ/P	50	–	750	14.4" x 7.1" x 9.3"	5,600	116	≥150,000	Wet	175W MH	P	Standard
74491	WALPAK2N/075UNV740/NC/BZ/P	75	–	740	14.4" x 7.1" x 9.3"	8,900	118	≥150,000	Wet	250W HPS/MH	P	Standard
74492	WALPAK2N/075UNV750/NC/BZ/P	75	–	750	14.4" x 7.1" x 9.3"	9,200	121	≥150,000	Wet	250W HPS/MH	P	Standard
74528	WALPAK3N/105UNV740/NC/BZ	105	–	740	18" x 9.37" x 9.84"	12,500	119	≥150,000	Wet	400W HPS/MH	–	Standard
74529	WALPAK3N/105UNV750/NC/BZ	105	–	750	18" x 9.37" x 9.84"	12,500	119	≥150,000	Wet	400W HPS/MH	–	Standard

\*LPW per LM79 report  
 \*\*Options: D = Daylight/Motion, P = Photosensor, E = Emergency  
 (MTO) = Made to Order  
 Note: All luminaires and retrofit kits are UL/ETL, FCC and RoHS



## Accessories and Replacement Parts

### Edge-Lit Panel

Item Number	Sales Part #	Product Description
70132	SMKIT1A/14A/WH	Surface Mount Kit 1' x 4'
70380	SMKIT1A/22A/WH	Surface Mount Kit 2' x 2'
70381	SMKIT1A/24A/WH	Surface Mount Kit 2' x 4'

### High Bay

Item Number	Sales Part #	Product Description
74449	HIBAY1A/BOTTOMLENS/16H5	Refractor Bottom Lens

### Linear High Bay

Item Number	Sales Part #	Product Description
71758	SENSOR1A/REMOTE/D	Sensor Remote
74597	LNHIBA1A/08IN/WG/WH	Wire Guard for 100W, 150W, and 165W versions
74598	LNHIBA1A/12IN/WG/WH	Wire Guard for 225W versions

### Vapor Tight

Item Number	Sales Part #	Product Description
74310	VAPOR1A/REMOTE	Vapor Tight (1A) Sensor Remote
74541	VAPOR1B/REMOTE	Vapor Tight (1B) Sensor Remote
74920	VAPOR1A/CONN/BL	Tandem Wiring Connector
74448	VAPOR1A/LENS/48EC	4ft Polycarbonate Replacement Lens
74538	VAPOR1X/LENS/48D5	4ft Diffused Lens
74744	VAPOR1X/LENS/24D5	2ft Diffused Lens

### Garage

Item Number	Sales Part #	Product Description
74921	GARAG1A/SHIELD	Glare Shield
71758	SENSOR1A/REMOTE/D	Sensor Remote
74550	GARAG1A/CONN/1/SV	Tandem Wiring Connector (Set of 1)
74551	GARAG1A/CONN/2/SV	Tandem Wiring Connector (Set of 2)
74745	GARAG1A/MTGPLATE/16/WH	16 inch Mounting Plate, Silver Finish

### Canopy

Item Number	Sales Part #	Product Description
74446	CANOPYA/MTGPLATE/12/WH	12" Mounting Plate
74447	CANOPYA/MTGPLATE/16/WH	16" Mounting Plate

### Slim Wall Pack

Item Number	Sales Part #	Product Description
74392	SLMWPK1A/JBOX/BZ	Junction Box
74393	SLMWPK1A/TRUNNION/BZ	Trunnion Mounting Hardware, Junction Box
74394	SLMWPK1A/KNUCKLE/BZ	Knuckle Mounting Hardware, Junction Box

### Wall Pack Cutoff

Item Number	Sales Part #	Product Description
74396	WALPAK1C/LENS/BZ	Replacement Lens

### Wall Pack Non-Cutoff

Item Number	Sales Part #	Product Description
74390	WALPAK1N/TOPVISOR/BZ	Top Visor (30W-80W)
74391	WALPAK1N/WIREGUARD	Wire Guard (30W-80W)
74397	WALPAK1N/LENS/BZ	Replacement Lens (30W-80W)
74445	WALPAK1N/PCLENS/BZ	Polycarbonate Lens (30W-80W)
74539	WALPAK3N/TOPVISOR/BZ	Top Visor (105W)
74540	WALPAK3N/WIREGUARD	Wire Guard (105W)
74595	WALPAK3N/LENS/BZ	Replacement Lens (105W)





Licensee of product  
trademark SYLVANIA  
in general lighting

LEDVANCE LLC  
200 Ballardvale Street  
Wilmington, MA 01887 USA  
Phone 1-800-LIGHTBULB (1-800-544-4828)  
[www.sylvania.com](http://www.sylvania.com)

SYLVANIA and LEDVANCE are registered trademarks.  
All other trademarks are those of their respective owners.  
Specifications subject to change without notice.

© 2017 LEDVANCE LLC

